

ELECTRONICTM

Servicing & Technology

OCTOBER, 1983
\$2.25

Taking the mystery out of decibel calculations

Audio test panels made simple

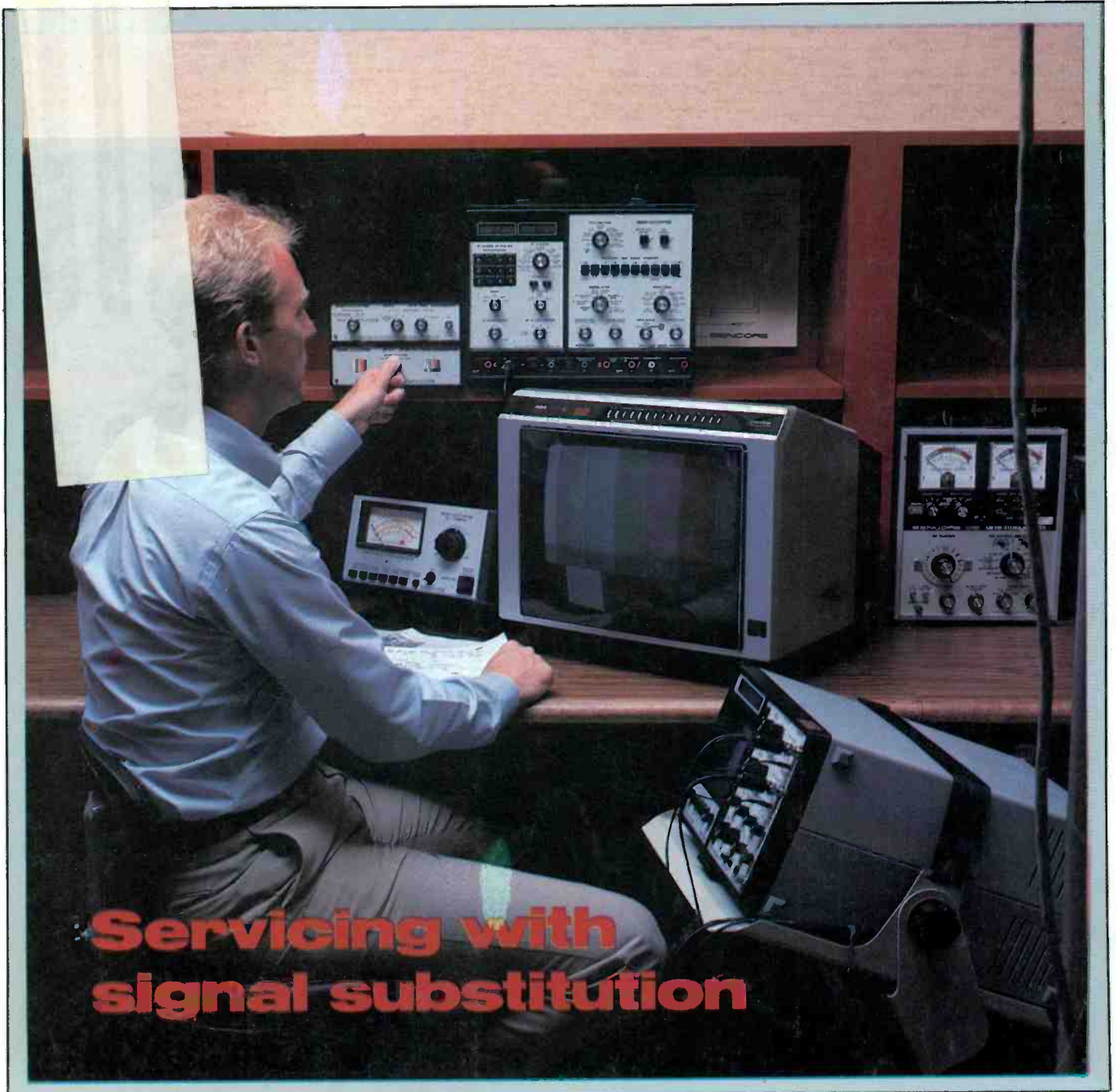

**Servicing with
signal substitution**

PTS CORPORATION
P.O. Box 272
Bloomington, IN 47402

PTS Tech Update

NEW!

PTS

Price and
Technical
Information
Guide
Effective
9/1/83

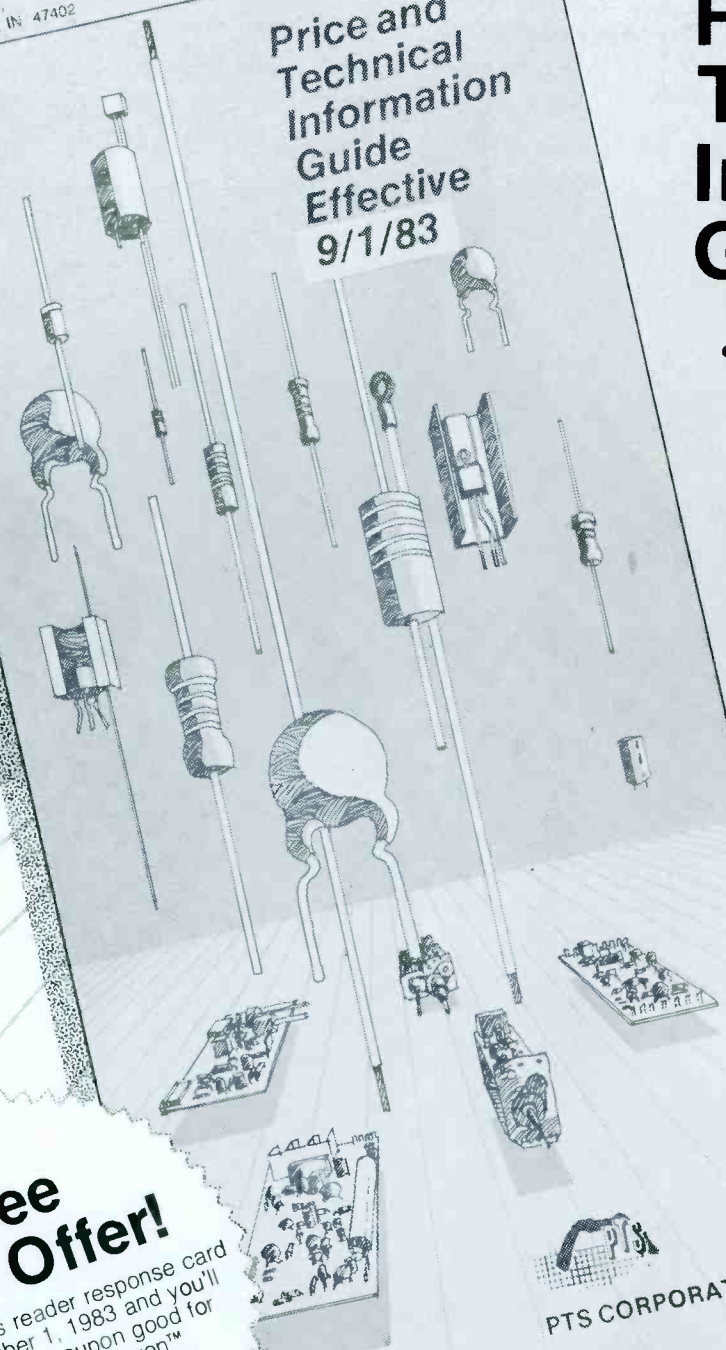

**Free
Tool Offer!**

Use this month's reader response card before November 1, 1983 and you'll receive a bonus coupon good for a free set of Dura-Seven™ TV-AM-FM Alignment Tools with your next PTS purchase. A \$2.50 value!!

Send for your Free Price and Technical Information Guide today!

- Complete listing of quality rebuilt PTS products. All makes. All models.
- The electronic industry's most complete substitution guide for television tuners and modules.
- Thousands of listings for TV tuners, TV modules, line amplifiers, converters, remote transmitters and PTS products.
- All makes and models repaired to manufacturers' specifications. Plus PTS automatic updates.
- All products are available at over 1500 stocking distributors or PTS Servicenters nationwide.

Available at:



PTS CORPORATION

Pick up your free copy at the PTS Servicenter nearest you or at over 1500 PTS distributor's nationwide.
Or circle #1 on the reader response card.

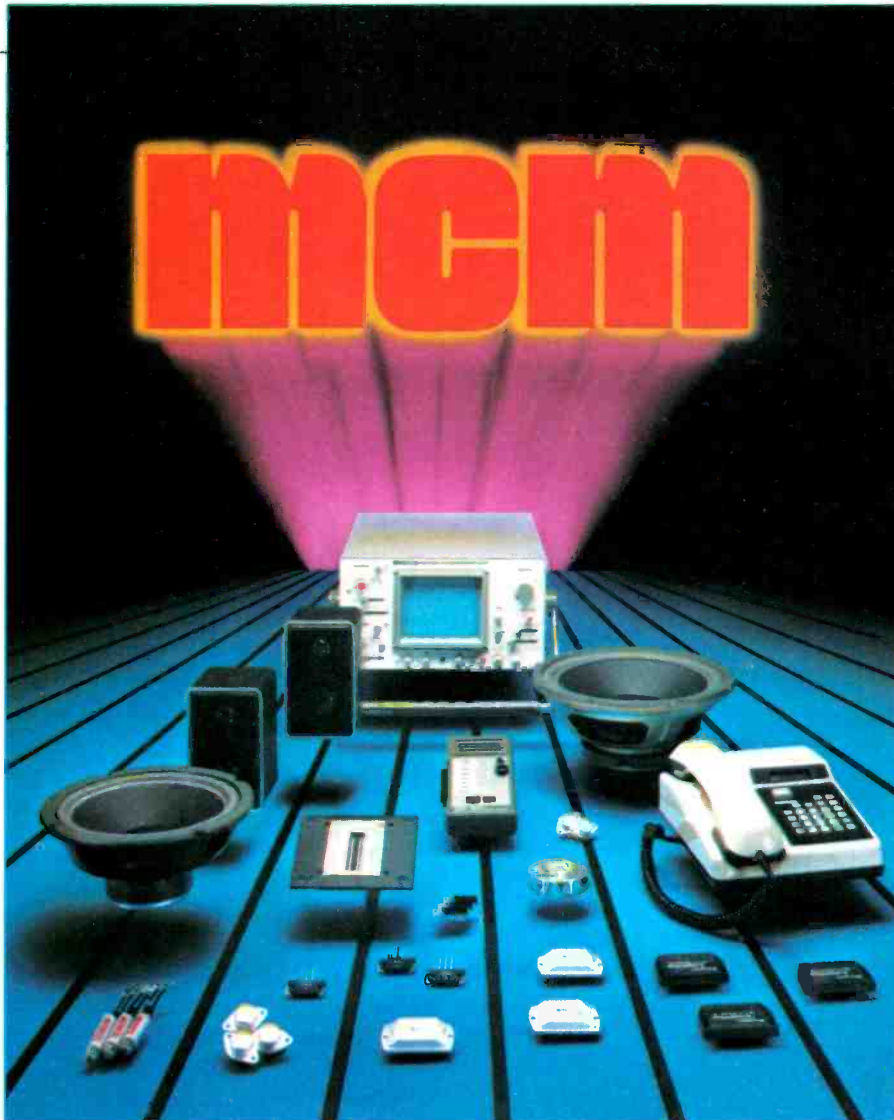

THE ONLY ELECTRONIC PARTS COMPANY YOU'LL EVER NEED.

You can hunt everywhere for hard-to-find parts and the most up-to-date radio, tv and computer components. Or you can call MCM.

MCM's wide selection of electronic replacement parts and original semiconductors are all high quality name brands such as Toshiba, NEC, Sanyo, Hitachi, Sony and Matsushita. **And they're in stock!**

MCM offers more than just the right parts. When we take your order, we make sure it's carefully packaged and shipped direct within 24 hours. We not only guarantee our parts, but our prompt, personal service as well.

Good service and quality electronic parts doesn't mean we're expensive. Check around. You'll find you can count on incredible savings with MCM.

Don't settle for second best . . . demand MCM electronic parts!

CALL TODAY for Your **FREE** copy of our **NEW** 96-page Summer Catalog.

CALL TOLL FREE 1-800-543-4330
(In Ohio 1-800-762-4315.)

ELECTRONICS

RIGHT PARTS, RIGHT PRICE,
SHIPPED RIGHT AWAY.

858 E CONGRESS PARK DR. CENTERVILLE, OHIO 45459

Circle (4) on Reply Card

October 1983 *Electronic Servicing & Technology* 1

The how-to magazine of electronics...

ELECTRONIC

Servicing & Technology

October 1983
Volume 3, No. 10

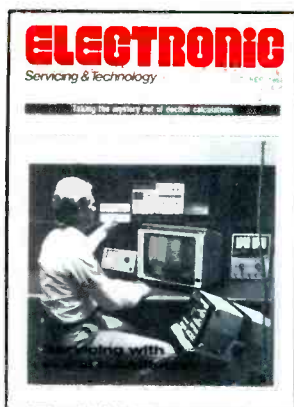

Signal substitution is a method of injecting known-good signals into a stage suspected of having a problem, then continuing backward, stage by stage, until the faulty stage is located. The article on page 10 describes the VA62, a microprocessor-controlled signal-substitution unit.

14 Reports from the test lab The Optoelectronics 7010S frequency counter

By Carl Babcoke, CET

This small, general-purpose frequency counter showed excellent stability and accuracy when tested.

18 Audio test panels made simple

By Bud Izen, CET/CSM

It is possible to construct a complete, versatile audio test panel without being an electrical engineer, as shown in this article.

22 Taking the mystery out of decibel calculations

By Sam Wilson, IS CET test director

This continuation in a series on decibels explains how calculations with decibels work and why they make electronics simpler.

44 Step-by-step earth station installation

By Tom Moore

Satellite receiving systems are springing up all over the country, and installers are profiting from the increase in sales. This article describes a specific installation.

46 Test your electronic knowledge

By Sam Wilson, IS CET test director

This month's questions are similar to those on the CET test section of questions that require mathematics.

48 Build your own logic probe

By Joe Sloop

These specifications, circuit descriptions and instructions will show you how to build an inexpensive and valuable tool for troubleshooting logic circuit problems.

52 Servicing the RCA CTC 108 unitized chassis, part 2

By Stan Vittetoe, CET

This continuation on servicing a unitized chassis is applicable to many manufacturers' units.



Page 14

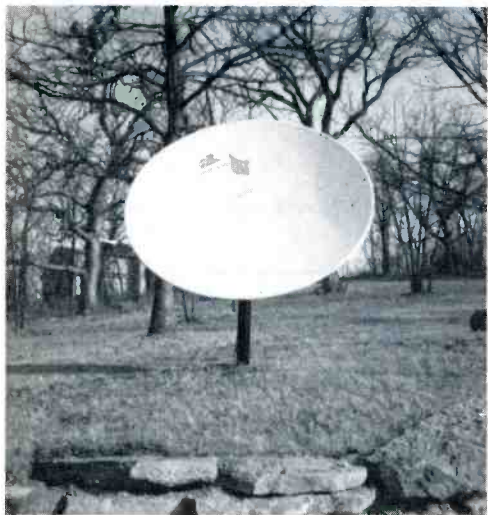

Page 44

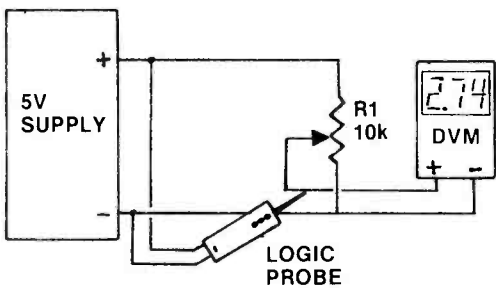

Page 48

Departments

- 4 Editorial
- 6 News
- 8 Technology
- 12 Symcure
- 29 Profax
- 38 Troubleshooting Tips
- 41 Photofact
- 42 Readers' Exchange
- 56 Products
- 60 Literature

Next month...

Troubleshooting symmetrical output circuits. Although there are many examples of this type of circuit, there are only three basic variations. This article will explain the push-pull transformer-coupled type, the true output-transformerless (OTL) type and the most common of the three, the quasi-complementary type.

What's new?

A short time ago, I was asked to give a presentation to a group of servicing technicians on an overview of new technology. I accepted eagerly. After all, there's so much happening in the area of new electronics technology it should be easy to find plenty to talk about.

Indeed, as I found out in doing research for the presentation, there is plenty to talk about. In fact, that became a problem. So much is happening on so many fronts that it defies analysis and defies any attempt to organize the information.

As I thought about what we call "new technology," or "technological development," it became increasingly clear that we're really talking about a number of things happening at the same time. The following categories are my own attempt to analyze the nature of different types of development and are subject to revision in the future.

Fundamental developments: These are developments in basic technology. One example of this is the discovery of the principle of thermionic emission, which led to vacuum tubes and all the early electronic circuitry. Another example of a fundamental development is the discovery of semiconductors, which, along with a host of refinements such as ICs, has led to so much of the electronic world we live in today.

System developments: These include the development of useful systems based on the products that came out of fundamental technological developments. Examples of this are radio, television, high-fidelity audio and computers.

Manufacturing/packaging developments: This

category includes such things as printed wiring, chip components and package design (IC dual-in-line packages for example). Developments of this nature can help reduce product size and manufacturing costs, and are important to consumers and servicers as well as manufacturers. Although such developments may ultimately contribute to technological advance, they do not of themselves truly advance technology.

These, as I see it, are the three primary aspects of technological development as it is so often reported. There are many others that are worth considering, and I will further discuss some of these concepts in future issues of **ES&T**.

With the continuing explosion of new devices and new products, it's sometimes hard to put it all into perspective. It helps to look at a "technological development" and try to determine just what type of development it represents. Sometimes the insights are startling.

For example, TVRO and DBS are exciting, fascinating TV signal delivery systems. But when you think about it, there's little that's really new about any of it. It's still a TV signal, in this case arriving at the receiving antenna at low power levels at high, but not new, frequencies. The only thing that's really new about satellite systems is the intriguing place they've put the transmitting antenna. On the other hand, that alone should qualify it for "high" technology.

Nils Conrad Persson

ELECTRONIC

Service & Technology

Editorial, advertising and circulation correspondence should be addressed to: P.O. Box 12901, Overland Park, KS 66212-9981 (a suburb of Kansas City, MO); (913) 888-4664.

EDITORIAL

Bill Rhodes, *Editorial Director*
Nils Conrad Persson, *Editor*
Carl Babcoke, *Consumer Servicing Consultant*
Rhonda Wickham, *Managing Editor*
Tina Thorpe, *Associate Editor*

ART

Kevin Callahan, *Art Director*

CIRCULATION

John C. Arnst, *Director*
Evelyn Rogers, *Manager*
Dee Manies, *Reader Correspondent*

ADMINISTRATION

R. J. Hancock, *President*
Cameron Bishop, *Publisher*
Eric Jacobson, *Associate Publisher*

ADVERTISING

Greg Garrison, *National Sales Manager*
Liz Turner, *Production Manager*
Robyn Kahn, *Marketing Coordinator*



Member, Audit Bureau
of Circulation



Member, American
Business Press

ELECTRONIC SERVICING & TECHNOLOGY is the "how-to" magazine of electronics. It is edited for electronic professionals and enthusiasts who are interested in buying, building, installing and repairing home-entertainment electronic equipment (audio, video, microcomputers, electronic games, etc.).

SUBSCRIPTION PRICES: one year \$15, two years \$26, three years \$34 in the USA and its possessions. Foreign countries: one year \$20, two years \$30, three years \$40. Single copy price \$2.25; back copies \$3.00. Adjustment necessitated by subscription termination to single copy rate. Allow 6 to 8 weeks delivery for change of address. Allow 6 to 8 weeks for new subscriptions.

PHOTOCOPY RIGHTS: Permission to photocopy for internal or personal use is granted by Intertec Publishing Corp. for libraries and others registered with Copyright Clearance Center (CCC), provided the base fee of \$2 per copy of article is paid directly to CCC, 21 Congress St., Salem, MA 01970. Special requests should be addressed to Cameron Bishop, publisher.
ISSN 0278-9922

ELECTRONIC SERVICING & TECHNOLOGY (USPS 462-050) (with which is combined Electronic Technician/Dealer) is published monthly by Intertec Publishing Corp., 9221 Quivira Road, P.O. Box 12901, Overland Park, KS 66212-9981. Second Class Postage paid at Shawnee Mission, KS 66201. Send Form 3579 to P.O. Box 12952, Overland Park, KS 66212-9981.



INTERTEC PUBLISHING CORP.

©1983 All rights reserved.



ALL THE BEST CHROMSTAR II

WINEGARD'S NEW EVOLUTIONARY LINE OF OUTDOOR ANTENNAS AND PREAMPLIFIERS

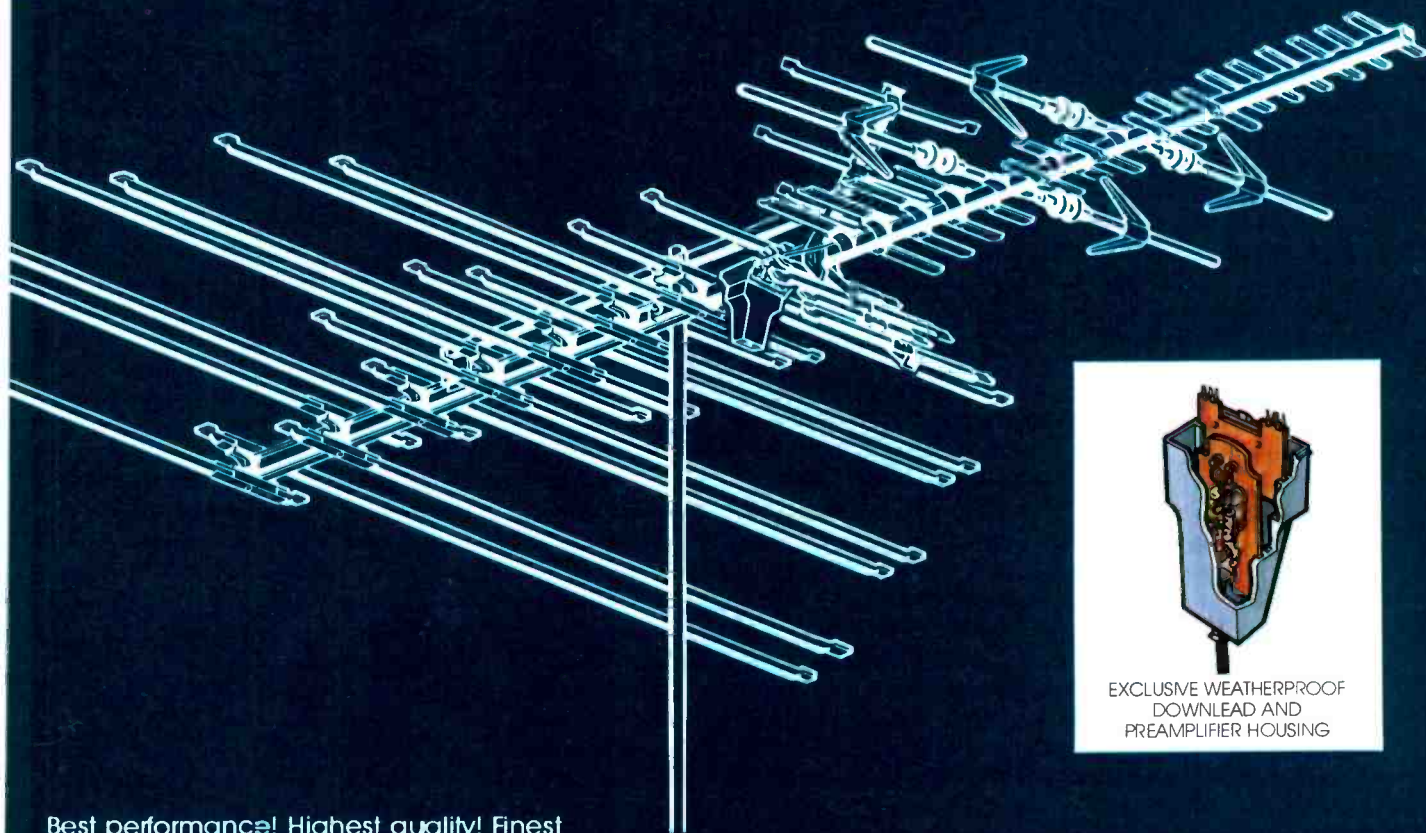

Best performance! Highest quality! Finest construction! Competitively priced! Antennas engineered in the Winegard tradition of quality and craftsmanship.

Chromstar II antennas feature the sharpest directivity, highest gain and more benefits than any competitive series. Models to satisfy every reception requirement.

Chromstar II antennas are rugged. High tensile aluminum alloy tubing provides rigidity and stability. Every antenna boasts famous Winegard anodizing—the only positive, permanent protection yet against corrosion and fading.

Chromstar II antennas are engineered for extra strength at all points of stress: scissor-type struts on wedge models; double boom on longer flatline models, high-impact girder design support insulators molded of super-tough G-E Noryl® plastic; preassembled snap-out corner reflectors on all 82-channel and UHF models; and truss-type phasing bars.

WINEGARD CHROMSTAR II PREAMPLIFIERS

The Chromstar II preamplifiers are Winegard's finest ever and at 13-35% lower cost! Designed for the ultimate fringe and deep fringe reception, these solid-state preamplifiers slip into the new, improved weatherproof cartridge housing at the point of the signal interception. There are a wide choice of models for VHF-UHF-FM, VHF-FM and UHF only.

The housing built into every Chromstar II antenna (or available separately for use on any antenna) is molded of clear G-E Lexan® to prevent breakage and provide protection against ultra-violet rays and chemical deposits.

Compare Winegard Chromstar II antennas and preamplifiers with competitive models. Compare construction. . . Compare performance. . . Compare price. . . You'll agree, Chromstar II antennas and preamplifiers set the quality and value standards for the industry.



EXCLUSIVE WEATHERPROOF
DOWNLOAD AND
PREAMPLIFIER HOUSING



WINEGARD®
TELEVISION SYSTEMS

WINEGARD COMPANY • 3000 KIRKWOOD STREET • BURLINGTON, IOWA 52601 • (319) 753-0121

Circle (5) on Reply Card

Customer service association's Annual conference set

The International Customer Service Association (ICSA) will hold its annual conference at the Westin Crown Center, Kansas City, MO, on Oct. 19-21, 1983.

The theme for this year's conference is *Service Excellence: The Competitive Edge*. The program will include general sessions covering topics with universal appeal to the general membership, workshop sessions covering specific topics of interest, and buzz groups consisting of informal breakout sessions. The multiple workshop session format will permit interaction among the session participants.

The International Customer Service Association is an organization of customer service professionals, dedicated to developing the customer service process. ICSA actively promotes professional development in customer service management, sound customer service practices, open discussion of and debate of consumer service issues, and investigation into emerging technologies and their application to customer service.

For additional information on the ICSA conference, or on ICSA, contact Neil Stone, Conference Chairman, c/o Thomas-Laguban & Associates, 16535 W. Bluemound Road, Brookfield, WI 53005; 414-784-7073.

World's first digital TV shown in Germany

The world's first production color TV sets using digital signal processing techniques, developed by ITT, were shown at the International Radio & Television show in September in West Berlin.

In the new sets, seven very large-scale integrated (VLSI) circuits are used to replace 300 conventional components. Both picture and sound signals are pro-

cessed in digital form in these televisions, with immediate advantages in terms of long-term stability of picture quality, true hi-fi stereo sound, simplified inclusion of videotex, more accurate and easier service adjustments and increased reliability.

The space made available by the reduction in the component count has been used to incorporate an enhanced audio section, with improved sound reproduction from a new base-response system.

Independent maintenance firms popular with users

Computer users have a much higher opinion of independent computer maintenance firms than most computer and terminal manufacturers believe, according to surveys conducted for Frost & Sullivan's new market research study, "Third Party Maintenance of Computers and Data Terminals in the U.S."

"We were surprised by the results of our surveys, which showed that most computer and data terminal users think third-party maintenance companies are as good or better than maintenance from the computer maker, often more responsive, and nearly always lower in price," said Joseph Savino, editor for Frost & Sullivan.

Many users were also found to be ignorant of third-party maintenance and how to get it, suggesting the industry "has a lot of marketing to do," according to Savino.

Frost & Sullivan forecasts 1987 industry revenues at \$1.3 billion, about double this year's projected \$680 million, which in turn is up 19% from last year's \$570 million. Independents now account for about 10% of the total computer and terminal maintenance market.

For more information on the report, contact Customer Service, Frost & Sullivan, 106 Fulton Street, New York, NY 10038; 212-233-1080.

RCA plans to introduce change in tube sizes

RCA has announced it is developing several new sizes of

color picture tubes that will provide squarer screens and a new look for future TV receiver designs. The first major change in industry screen sizes in 13 years will reach the consumer market in mid-1984 as RCA begins producing a new 26in (diagonal) screen size.

RCA is also developing 20in, 14in and 16in color picture tubes. This family of tubes will be available for sale to TV receiver manufacturers beginning in 1984. This new series of picture tubes will feature a distinctively squarer picture and incorporate all advantages of the new RCA COTY-29 system introduced this fall.

Existing color picture tubes—13in, 15in, 19in and 25in sizes—employ a design that curves inward at the sides of the viewing screen and rounds off the corners. This causes a reduced sharpness of images in the corners of the picture. The new RCA "full square" tubes provide a more rectangular picture with greater picture area.

Matsushita develops digital TV featuring sharper images

Matsushita Electric Industrial Company has announced the development of a multifunctional digital TV set, which offers crisp images and expanded capabilities due to digital video circuitry. The TV is scheduled to be marketed in the United States in late 1984.

Unlike analog television, Matsushita's digital television can easily incorporate a tuner and adapter for videotex and teletext, and will hook up directly with home computers, stereos, VCRs and other forms of component television.

The digital television uses two ICs and four LSIs, including a newly developed microcomputer CPU. The television has 30% fewer components than conventional analog sets, which reduces cost and increases reliability.

Current analog TV sets generate pictures by processing analog signals, which are sent out by TV stations. Matsushita's new television converts these analog video signals into digital signals, giving a cleaner image due to reduction of spots, screen flickering and color saturation.



The complete library of replacement semi's.

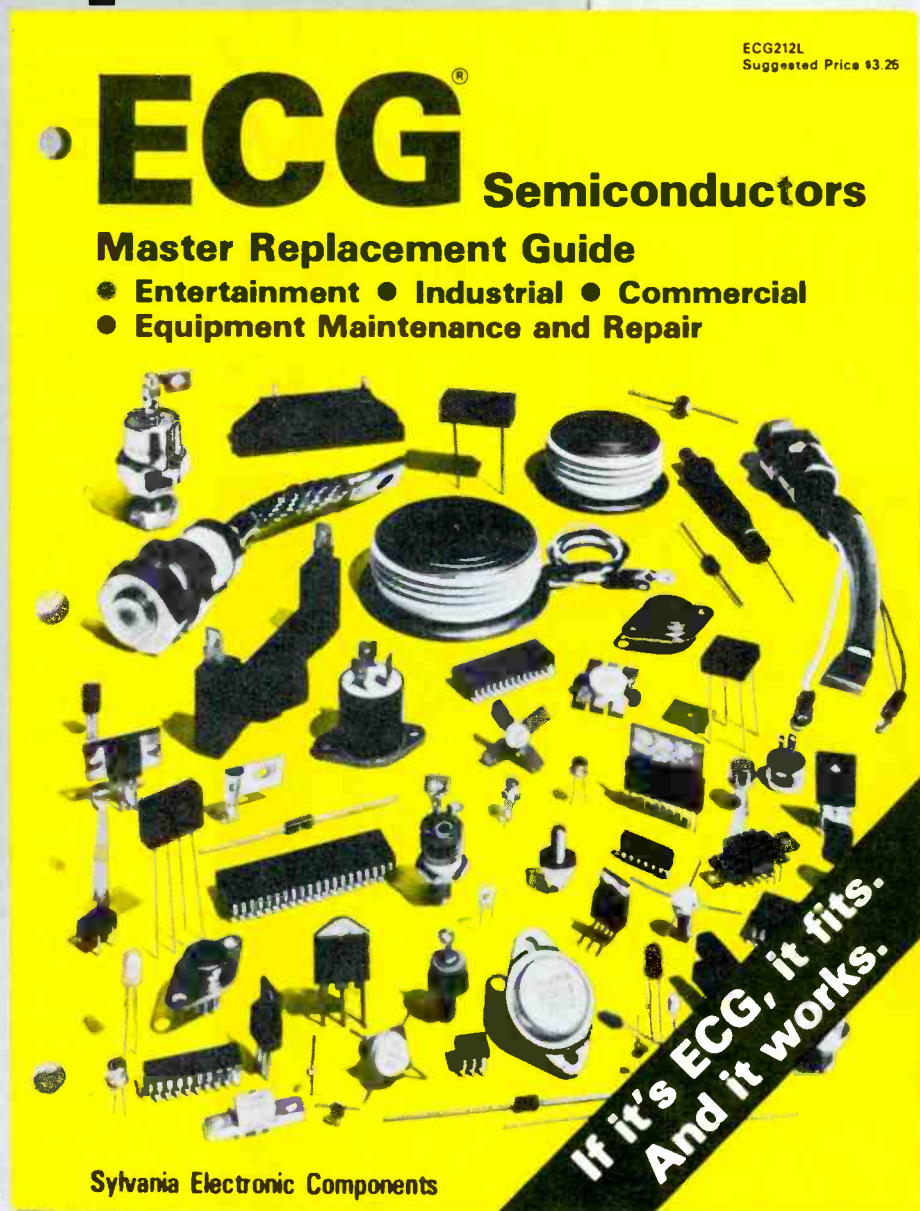

Here's the one guide that has it all—the new ECG® Master Guide. It's 545 pages, packed with over 3000 ECG semiconductors that replace over 200,000 industry numbers. And our replacements meet or exceed the specs of the original parts. So if it's ECG, you can count on it to fit and work.

Reduce equipment downtime and save yourself endless hours of parts hunting. For everything from analog amplifiers to zener diodes, go with replacement semiconductors from ECG. Get your new ECG Master Guide and our "Counterpoints" product updates from your nearest distributor. For his name and number, call 1-800-225-8326 toll-free (in Massachusetts, dial 1-617-890-6107). Or just send \$3.25 for your ECG Master Guide to Philips ECG, Inc., Dept. EST, 70 Empire Drive, West Seneca, NY 14224.

**If it's ECG, it fits.
And it works.**

Philips ECG

A North American Philips Company

A scope, DMM and recorder all in one



Advances in flat-plan LCD technology have enabled BBC-Metrawatt/Goerz to introduce a new digital scope multimeter that measures only 10" x 7" x 3.5" when folded and weighs only 4.3 lbs. Model M 2050 combines the capabilities of a low-frequency digital oscilloscope, a 3½-digit multimeter and a transient recorder with two independent memories.

Measurements can now be evaluated more accurately because the scope and the multimeter operate simultaneously. For example, while the oscilloscope portion of the display is used to evaluate signal characteristics, the DMM portion of the display can be used to display the true RMS value of the signal. The 3½-digit multimeter capabilities include 15 voltage ranges (to 650V), 15 ranges for current to 10A (20A to 30S), and two resistance ranges (200Ω and 20kΩ).

Because the inputs were designed with the voltage and current-handling characteristics of a DMM in mind, the digital scope multimeter can be used directly for high-voltage power measurements. The operator can apply 500V to the 200mV range without damaging the instrument, and 780V overload protection is provided on the other voltage ranges. For current and resistance measurements, the overload protection is 500V (with the exception of the 10A range).

Operating as a scope, the M 2050 digitizes analog signals at a 500kHz rate. At 10 samples per cycle, the effective bandwidth is 50kHz. Triggering selections include *auto*, *manual*, *internal*, *external* and *roll*. The *roll* trigger mode is useful to monitor slow inputs. In the *roll* mode, the M 2050 operates in much the same fashion as a strip chart recorder. Users can select from

(Courtesy of BBC-Metrawatt/Goerz.)

Now 60 MHz or 100 MHz Tek quality is just a free phone call away!



Tek has expanded its best-selling 2200 scope line up to 100 MHz. And brought it all as close as your phone. Tek's revolutionary, reduced-component architecture brings unprecedented quality, reliability and affordability to the 60 MHz 2213 and 2215, and now, the 100 MHz 2235.

All three of these lightweight (13.5 lb.) scopes feature 2 mV/div vertical sensitivity and 5 ns/div sweep speeds, plus a complete trigger system for stable triggering on digital, analog or video waveforms.

Scopes with a comprehensive 3-year warranty* ... probes... and expert advice. One free call gets it all! You can order, or obtain literature, through the Tek National

	2213	2215	2235
Bandwidth	60 MHz	60 MHz	100 MHz
No. of Channels	2	2	2 + Trigger View
Alternate Sweep	—	Yes	Yes
Vert/Trig B/W Limit	—	—	Yes—20 MHz
Single Sweep	—	—	Yes
Accuracy, Vert/Horz	3%	3%	2%
Delay Jitter	1:5,000	1:10,000	1:20,000
Trigger'g Sensitivity	0.4 div at 2 MHz	0.4 div at 2 MHz	0.3 div at 10 MHz
Input R-C	1M Ω -30pf	1M Ω -30pf	1M Ω -20pf
Variable Holdoff	4:1	4:1	10:1
Price	\$1200†	\$1450†	\$1950†

Marketing Center. Technical personnel, expert in scope applications, will answer your questions and expedite delivery. Direct orders include operating and service manuals, two 10X probes, 15-day return policy, and worldwide service back-up.

**Call toll-free:
1-800-426-2200,
Extension 65.**

In Oregon, call collect:
(503) 627-9000, Ext. 65.

†Price FO B. Beaverton, OR
*3-year warranty includes CRT and applies to 2000 family oscilloscopes purchased after 1/1/83.
Scopes are UL Listed, CSA and VDE approved.

Tektronix
COMMITTED TO EXCELLENCE

Circle (6) on Reply Card

What's inside the VA62?

0.1ms/DIV to 6min/DIV. At 6min/DIV, the total time window displayed is 1 hour.

The transient recording capabilities of the M 2050 enable operators to use two independent 0.5k x 8 bit memories to record data. It can capture and store events as brief as 2ms. The versatile triggering options of the M 2050 enable users to select the amount of pre- and post-trigger data, (-100% to +100%), that they want stored.

Once recorded, data from either memory can be recalled and displayed for analysis. The low-power design of the M 2050 makes it possible to retain waveform data for months, if desired.

For comparisons with other measurements and other detailed evaluations, the M 2050 features an analog output. This enables a hard copy record of waveform data to be made via a strip chart recorder.

The M 2050 is an instrument that is designed to be easy to use. The multimeter, oscilloscope and transient recorder controls are grouped together and are color-coded. For users familiar with scopes and DMMs, the time required to learn how to operate the M 2050 is negligible. For extended measurement capabilities, the M 2050 is fully compatible with BBC high-voltage (30kV), and high-current (10,000A) accessories.

The flat-panel LCD of the M 2050 gives the instrument several advantages. The M 2050 presents distortionless images with uniform contrast across the high-resolution, 128 x 64 dot LCD. The folding design enables users to adjust the viewing angle of the display. This design also enhances the portability of the instrument.

The unit even shuts itself off, but retains the information stored in memory, when closed. Nickel cadmium batteries that provide eight hours of portable operation are available. **ES&T**

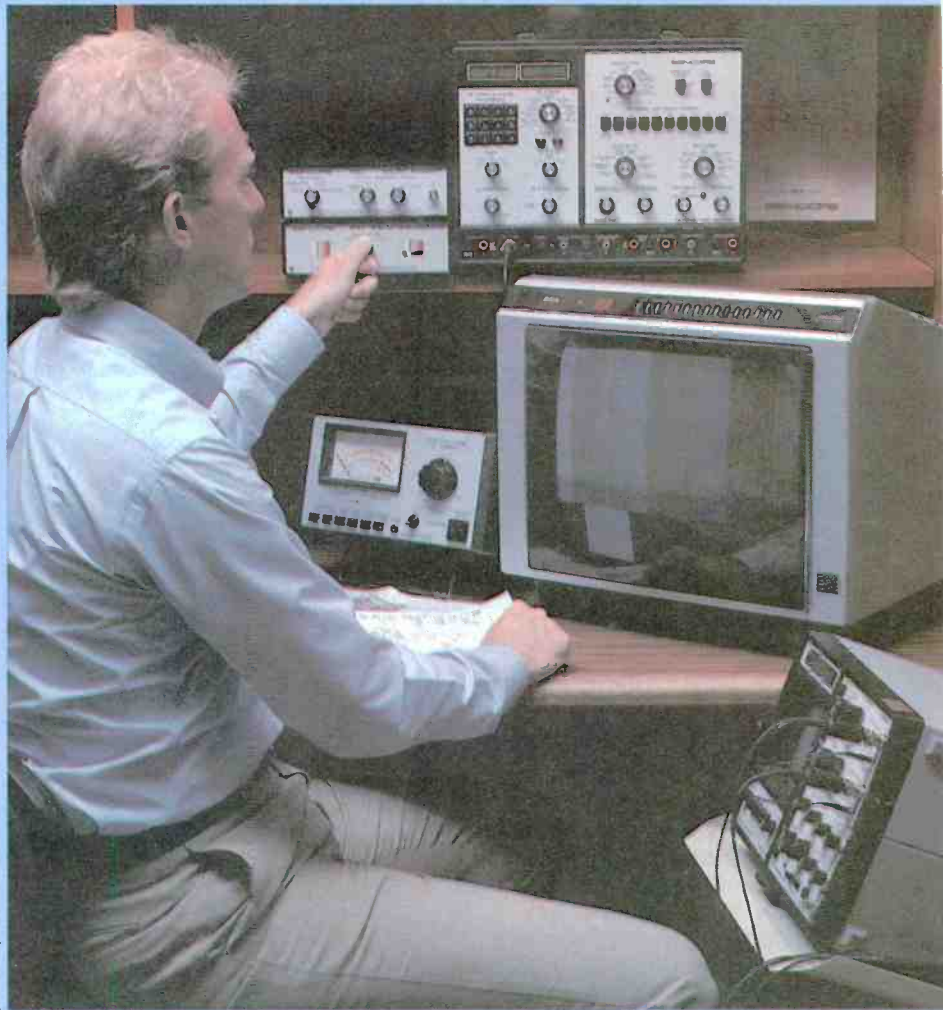

(Courtesy of Sencore)

A newly designed video analyzer uses two microprocessors to independently control separate functions and drive its two LCD displays. In the VA62 Universal Video Analyzer by Sencore, one micro controls the RF/IF section and the other the digital meter.

The unit's RF generator provides all 142 TV channels (all 82 VHF and UHF channels plus 60 midband, superband and hyperband cable channels) to fully test any TV tuner, including the new digital "cable ready" models. Audio modulation may be added to any channel to isolate audio problems.

The RF/IF microprocessor controls the RF generator to

produce the channel requested through the keyboard or by the up/down buttons. The micro also memorizes individual frequency shifts programmed into the analyzer by the user for any of the 72 cable channels to duplicate the shift found in any cable system. This allows accurate testing of every receiver operating on cable. Each channel can be shifted up to 9.75MHz above or below the FCC-assigned frequency to duplicate any shifting scheme. The VA62 selects between shifted frequencies (in the programmable function) or standard FCC frequencies (in the standard function) without needing to reprogram the generator.

The shifts are stored in EEPROM (Electrically Erasable Programmable Read Only Memory), meaning the memory does not require power or batteries to maintain data. Because the memory is programmable, the frequency shifts may be changed as often as desired by simply keying the new shift into the keyboard. Special routines in the micro allow the direction of the frequency shift to be temporarily changed (without reprogramming the memory) for special tests of automatic fine-tuning circuits.

Reduced error

The RF/IF micro also provides a feature that reduces output attenuator error. Each VA62 is connected to a computer at the factory, which steps it through all channels while measuring the amplitude of the RF output. The RF measurements are then used to burn a PROM (Programmable Read Only Memory), which tells the microprocessor how much compensation to apply to the dc-controlled attenuator for each channel in order to keep the output flat across the band. The result is a flatness of 1dB at 1000 μ V from Channel 2 (55.25MHz) to cable Channel 68 (487.25MHz) for accurate sensitivity tests.

The microprocessor that controls the digital meter has three main functions. First, it translates the output of the digital meter circuits to the signals needed to drive the LCD display. This allows control of the number of digits of resolution displayed by the meter so the internal monitor functions remain easy to use. If this were not done, the PPV readings would have too much resolution, making it virtually impossible to adjust the signal controls for stable readings.

Second, the micro operates the autoranging circuits for the internal signal monitoring functions and the external circuit measurement tests of dc volts and PPV. This eliminates the need for range switching, allowing all eight of the meter functions to be operated with a single knob.

Third, the micro operates the internal and external peak-to-peak monitoring circuits, which measure the positive peak and the negative peak of the signal (using successive approximation techniques) and then add the two readings together. This provides the high-frequency response (30Hz to 5MHz, \pm 1dB) needed for accurate signal measurements.

The meter monitors the two isolated outputs (the drive output and the dc power-supply output) through high-speed opto-isolators, allowing the outputs to be floated above chassis ground by up to 1500V (dc plus peak ac). This allows the unit to be used for applications requiring common connections at test points other than chassis ground without affecting circuit operation. Examples include driving the output transistor in circuits using "split flybacks" (which float the emitter of the horizontal output transistor 400V P-P above ground), driving stages in circuits using dual-ground (hot-ground/cold-ground) power supplies or driving differential (ungrounded) circuits.

Signal substitution

The VA62, like its predecessor the VA48, operates on the principle of injecting known-good signals into a stage that may have a problem. If you get a good picture on the screen, you know everything is working from that point to the output. You then back up, stage by stage, until the defect appears on the screen. You then know you are injecting into the defective stage.

Traps for cable systems

The VA62 offers a new method to set traps by viewing the TV screen. A fully modulated video carrier mixes with a crystal-controlled interference carrier to duplicate the interference that the traps must eliminate. You inject a video pattern, and the interfering signal, which the trap will eliminate, at the IF input. Because of its dynamic nature, the three trap-setting signals work effectively on any IF stage, including the new SAW (Surface Acoustic Wave) filter designs.

Other features

Two improved video patterns dynamically test the latest comb filters. The new multiburst bar sweep has 10 frequency bars (from 0 to 4.5MHz) to confirm that the comb filter provides the correct luminance frequency response. The improved chroma bar sweep pattern provides both chroma and luminance signals to dynamically test the filter's capability of separating the color signals.

A standard VIR signal can be selectively added to any of the video patterns. This provides a reference to dynamically test the VIR circuits without resorting to an off-the-air signal.

Both interlaced and non-interlaced signals are available to dynamically test both modes of operation. An *Interlace Adder* button switches the VA62 between its two modes.

An expanded range of substitute drive signals, with a 3V, 30V and 300V (peak-to-peak) full-scale driving range is available for high-sensitivity ICs. Digital metering prevents circuit damage from applying signal levels too high in amplitude and shows when feeding a shorted stage.

Drive signals and built-in digital voltmeter provide a dynamic test of the tripler, whether a separate component or built into a flyback. Also, a reliable ringing test tests deflection yokes and flyback transformers.

Accessories

The signals supplied by the VA62 are the ones common to all video servicing. The unit's add-on feature allows accessories to be added as needed for new formats or special applications. All accessory signals are phase-locked and sync-locked to the other VA62 signals so they can be used for signal substitution as if they were coming directly from the VA62.

Presently, there are two accessories available. The VC63 turns the VA62 into a full VCR analyzer. The NT64 produces NTSC color-bar patterns if needed for special applications.

ES&T_{inc}

**Chassis—General Electric N-2
PHOTOFACT—1219-1**

1

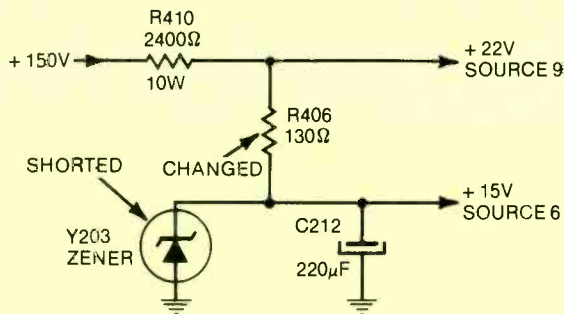

Symptom—No raster or HV; horizontal oscillator is dead
Cure—Check zener diode Y203, and replace it if shorted

**Chassis—General Electric 19JA
PHOTOFACT—1328-2**

2

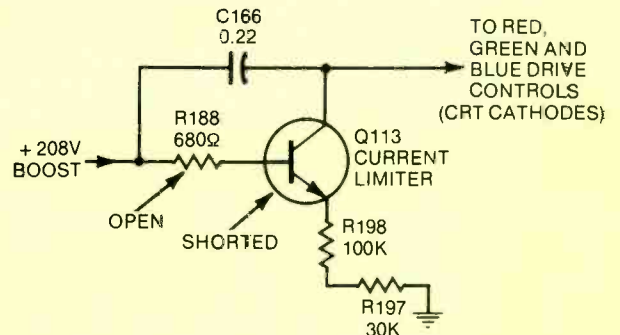

Symptom—Excessive brightness with weak contrast
Cure—If CRT has insufficient bias, check for shorted Q113 and open R188

**Chassis—General Electric 17YA
PHOTOFACT—1578-1**

3

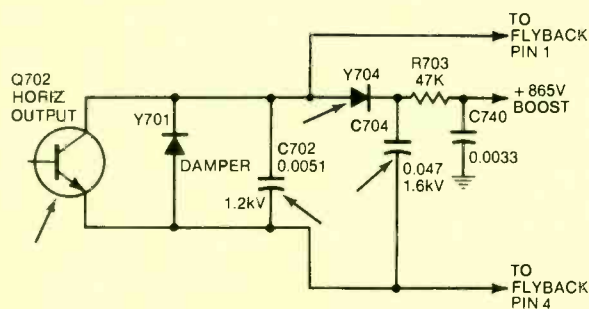

Symptom—No sound or picture
Cure—If fuse and Q702 output transistor are defective, replace them and check for ends blown out of C702 and C704 (replace with 1.6kV rating)

**Chassis—General Electric 25YM
PHOTOFACT—1780-1**

4

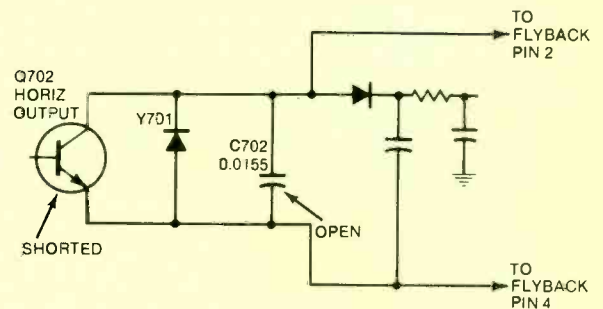

Symptom—No sound or picture; line fuse is blown and horiz-output transistor
Cure—Check T710 flyback by ringing (a plug-in unit) and replace it if turns are shorted. Also, carefully test C702 and replace if defective

**Chassis—General Electric AB (also AC)
PHOTOFACT—1904-1**

5

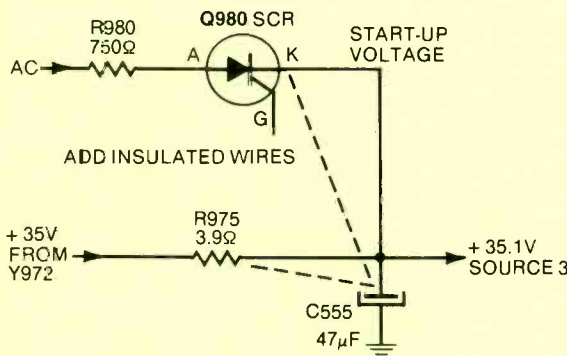

SYMPTOM—Dead (failure to start-up) or erratic shut-down
Cure—Add insulated wires between R975, C555 and the cathode of SCR Q980

**Chassis—General Electric AB (also AC)
PHOTOFACT—1904-1**

6

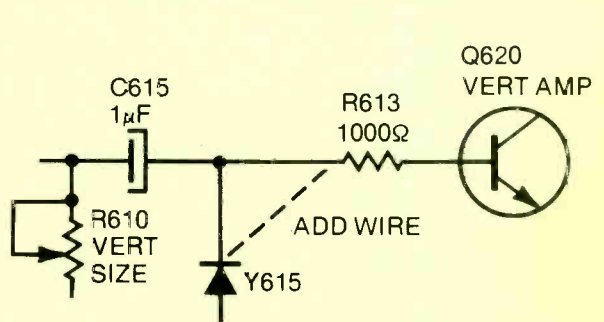

Symptom—No height, miscentered horizontal line, and R650 is hot
Cure—Solder an insulated wire between R613 and the Y615 cathode as shown

THINKING TVRO?

Take A Look At Winegard!



Excellent picture quality and low cost. That's what you get with Winegard's SC-5000S home satellite television system.

You'll discover that Winegard's 8-foot package incorporates all the latest in TVRO solid-state design and engineering for a dramatic difference in satellite TV reception. All the features that your customers want are there!



Why Buy Winegard Home Satellite TV Reception Products?

All Your Satellite Product Needs From One Source • Competitive Pricing • Easy to Handle, Ship and Inventory • All Satellite Products Backed By A Full-Year Warranty • Easy-To-Install • Complete And Professional Factory Support And Service • Rigid Quality Control Standards For Satellite TV Products

SC-7032S RECEIVER FEATURES:

- Rapid Scan Control
- Polarity Switch
- Audio Tune
- Signal Strength Meter
- Fine Tune
- Channel Select Control
- Satellite Select
- Remote Control Optional

SC-8009 ANTENNA FEATURES:

- 8-ft. Durable Spun Aluminum Reflector with Weather Resistant White Epoxy Finish
- Easy Handling and Shipping
- Complete Arc Coverage
- Choice of Rugged Pedestal or Post Polar Mounts
- Prime Focus Feed with Automatic Electronic Polarity Switching
- 90mph Wind Survival



WINEGARD COMPANY • 3000 KIRKWOOD STREET • BURLINGTON, IOWA 52601 • (319) 753-0121

Write for information about SASA, the professional satellite TV installers network.

Reports from the test lab:

By Carl Babcoke, CET

The Optoelectronics 7010S frequency counter

Model 7010S from Optoelectronics is a small, general-purpose frequency counter that measures signal frequencies from 10Hz to more than 600MHz. The ER-1000 option extends the upper limit to 1000MHz. The size of the black

aluminum cabinet is 1 $\frac{3}{4}$ "x4 $\frac{1}{4}$ "x5 $\frac{1}{4}$ " and weighs only 1 pound without the battery pack or 1 $\frac{1}{4}$ pounds with batteries. Optional equipment consists of a combined wall plug and step-down transformer that provides ac power for the counter,

plus charging for the Ni-Cd batteries. The unit can be operated from 12V auto systems or other external supplies. Maximum charge time for the Ni-Cd batteries from a completely discharged state is about 14 hours. The counter will operate solely on the Ni-Cd internal batteries for 30 minutes to 2 hours, depending on the functions selected and how many LED digits are lighted.

Nine red LED digits are provided in the digital display, which has automatic decimal-point positioning and automatic leading-zero suppression (all zeros before the most-significant digit are unlit to save power).

Ranges

Three frequency ranges and three gating (signal-sampling) times are provided for flexibility. Range 1 covers from 10Hz to 12MHz; range 2 covers from 10Hz to 60MHz. The input jack for these

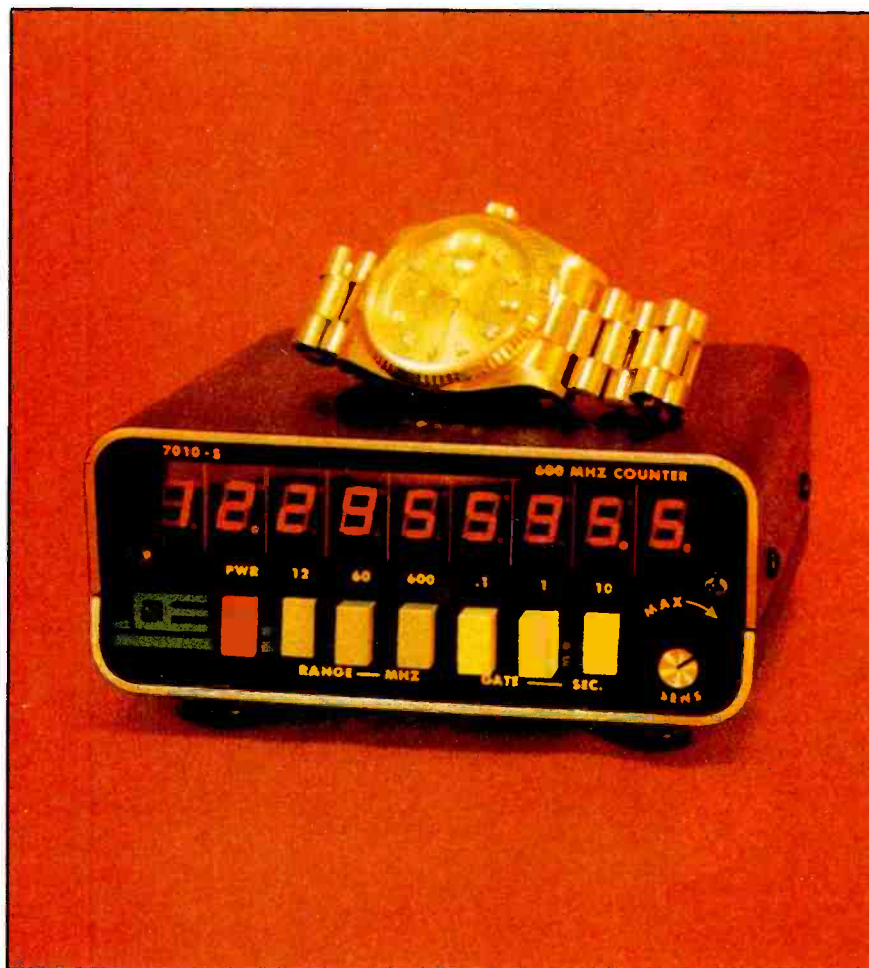

Each report about an item of electronic test equipment is based on examination and operation of the device in the ES&T laboratory. New and useful features are discussed, along with tips about using the equipment for best results. Personal observations are given about the performance or other important attributes.



performance by design

Folding Meters are Better

Not all multimeters fold. There's a reason. While other manufacturers were busy copying each others designs, BBC looked at where portable meters were used and how they could be improved.

The result is a unique approach. Folding meters with large displays (18 mm LCDs) and adjustable viewing angles. Now you can have high performance in a meter that excels in the field and on the bench.

Hands Free vs Handheld

In multimeters "hands free" is significantly better than "handheld." You need three hands to operate the typical "handheld" meter in the field. One for the meter and two for the probes. BBC's folding design lets you use a neck strap for the meter. This frees your hands for the probes.

On the bench, the large, adjustable displays pay off. It's a sensible design that lets you make measurements faster and more easily.

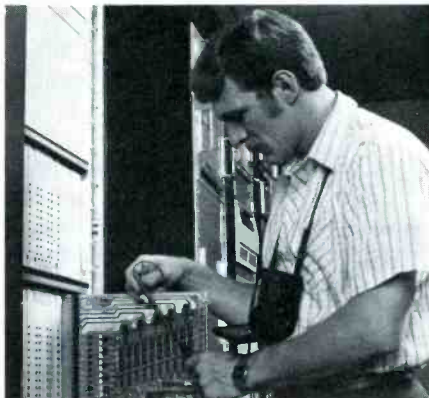

A Heritage of Precision

BBC's track record of expertise in precision engineering spans eight decades. All our meters are built to tough VDE and DIN safety standards. The 3½-digit DMM's feature 0.1% basic dc accuracy and externally accessible fuses for overload protection.

Compact, Rugged and Affordable

To design the impact resistant case that protects these DMM's, BBC relied on the industrial design skills of the Porsche Design Studios.

When open, the display angle is easily adjustable. When closed, the display and the controls are protected, and the meters turn off automatically. Competitive pricing is another feature of BBC meters. Prices start at \$193.00.

Available Locally

BBC meters are available throughout the U.S. If your instrumentation supplier doesn't carry BBC yet, we'll gladly tell you who does. Call toll free:

1-800-821-6327
(In CO, 303-469-5231)

BBC - METRAWATT/GOERZ
6901 W. 117th Avenue
Broomfield, CO 80020, Telex 45-4540

Engineering Excellence in Test and Measurement



Circle (8) on Reply Card

two ranges is on the rear panel. The impedance at the BNC jack is $1\text{M}\Omega$ and 20pF (high impedance). Another rear-panel BNC jack has a 50Ω impedance for range 3, which counts between 25MHz and 600MHz (or 1000MHz with the ER-1000 option). The low-impedance input is preferred for RF systems of that impedance because it minimizes ringing and reduces the pickup of unwanted signals or noise.

A rotary control on the front panel adjusts the sensitivity to prevent wrong counts from noise or ringing on the signal. A red LED at the lower right edge of the display blinks on when a reading is being updated. The gate-light indicator and sensitivity control operate for all ranges and conditions. Signals without excessive noise can be counted down to about 10mV below 500MHz , or down to about 20mV above 500MHz .

Counter considerations

Digital counters actually count the number of individual cycles that are received during a precise period of time. Because the signal frequency and the counting frequency are not synchronized, there is an unavoidable error of ± 1 count in all readings. This error occurs in the least-significant digit (the one at far right) and it offers no problem when seven, eight or nine LED digits are in use. However, the error can be serious if a

10Hz frequency is to be counted accurately, because the error might be 10% to 20%. Therefore, high accuracy demands the display of many active digits.

The other source of counter error originates in the gate-timing circuit. Of course, a crystal oscillator is always used, but even so, there is some drift. For critical measurements, a counter with an oven for a temperature-controlled oscillator is preferred. Optoelectronics model 7010S can be obtained with an OCXO (oven-controlled crystal oscillator) that gives one-tenth the drift.

When the standard TCXO (temperature-compensated crystal oscillator) is used, the drift is rated at ± 1 parts-per-million (PPM) without a warm-up period. This is reduced to ± 0.1 PPM when the OCXO option is selected.

Comments about performance

In the absence of a high-accuracy standard, the Optoelectronic model 7010S was compared to other counters when the output of a signal generator was measured. The stability far exceeded the results obtained several years ago when other models were checked. For example, the older counters often refused to count the output of an audio generator or the 6.3V tube-heater supply, instead giving readings that varied widely. Model 7010S gave a 60.0Hz reading for the low-voltage output of a power transformer.

Tests of various frequencies emitted from a sine/square generator gave excellent results, although the decimal change from megahertz to hertz readings was a surprise, because the instruction manual did not mention it. Range 1 (10Hz to 12MHz) gave the best resolution for the test frequencies. A 40.04Hz sinewave signal showed 0.00004MHz with the 0.1s gating time (5 digits), 0.000040MHz with the 1s time (six digits), and an abbreviated reading of 40.0 (apparently hertz) with the 10s time. Of course, 40.0Hz equals 0.0000400MHz (7 digits), so the 40.0 reading gave 7-digit resolution.

Other tests at 2.00222MHz (upper limit of the generator) gave the following readings: 0.1s showed 2.00221 (apparently megahertz with six digits); 1s showed 2.002218MHz (seven digits) and 10s showed $2,002,209.2$ (apparently hertz) for eight digits. Any slight variation between the readings apparently came from the generator, because both counters deviated about the same.

The owner's instruction manual clearly describes noise, ringing and other conditions that can cause false readings, along with suggestions for obtaining reliable and stable readings.

Optoelectronics model 7010S frequency counter performed all tests satisfactorily, and is recommended for any uses for which it is designed.

Circle (130) on Reply Card

Now electronics technicians can get into VCR Servicing quickly and easily

Learn professional VCR servicing at home or in your shop with exclusive videotaped demonstrations

Today, there are more than 10 million VCRs in use, with people standing in line to have them serviced. You can bring this profitable business into your shop with NRI professional training in VCR servicing. This top-level training supports the industry's claim that the best technicians today are those who service VCRs.

Integrated Three-Way Self-Teaching Program

In one integrated program, NRI gives you a study guide, 9 instructional units, 2 hours of video training tapes accompanied by a 32-page workbook that pulls it all together. At home or in your shop, you'll cover all the basic concepts of video recording, mechanical and electronic systems analyses, and the latest troubleshooting techniques. Your workbook and instructional units also contain an abundance of diagrams, data, and supplementary material that makes them valuable additions to your servicing library.

The "How-To" Videotape

Your NRI Action Videocassette uses every modern communications technique to make learning fast and easy. You'll enjoy expert lectures and see animation and video graphics that make every point crystal-clear. You'll follow the camera eye into the heart of the VCR as step-by-step servicing techniques are shown. Both electronic and mechanical troubleshooting are covered . . . including everything from complete replacement and adjustment of the recording heads to diagnosing micro-processor control faults.

Plus Training On All The New Video Systems

Although your course concentrates on VCRs covering Beta, VHS, and 3/4" U-Matic commercial VCRs, NRI also brings you up to speed in other key areas. You'll get training in capacitance and optical video disc players, projection TV, and video cameras. All are included to make you the complete video technician. There's even an optional final examination for NRI's VCR Professional Certificate.



Covers Beta and VHS systems with actual instruction on videotape.

The Best Professional Training

This exclusive self-study course has been developed by the professionals at NRI. NRI has trained more television technicians than any other electronics school! In fact, NRI has consistently led the way in developing troubleshooting techniques for servicing virtually every piece of home entertainment equipment as it appears in the marketplace.

Satisfaction Guaranteed . . . 15-Day No-Risk Examination

Send today for the new NRI Self-Study Course in VCR Servicing for

Professionals. Examine it for 15 full days, look over the lessons, sample the videotape. If you're not fully satisfied that this is the kind of training you and your people need to get into the profitable VCR servicing business, return it for a prompt and full refund, including postage. Act now, and start adding new business to your business.

Special Introductory Offer

This complete VCR training course with two hour videotape is being offered for a limited time only, on orders received from this ad, at our low introductory price of \$179.95. Save \$20 by acting now!

NRI Training For Professionals
McGraw-Hill Continuing Education Center
3939 Wisconsin Avenue Washington, DC 20016

YES! Get me started in profitable VCR servicing. Rush me my NRI self-study course in VCR Servicing for Professionals. I understand I may return it for a full refund within 15 days if not completely satisfied.

PLEASE SPECIFY TAPE FORMAT DESIRED VHS BETA

Name (please print) _____

Company _____

Street _____

City/State/Zip _____

Enclosed is my check money order for \$179.95 (D.C. residents add 6% tax) Make check payable to NRI

Charge to VISA MasterCard _____

Interbank Number _____

Card Number _____ Expiration Date _____

Signature _____

(required for credit card sales)



NRI Training For Professionals
McGraw-Hill Continuing
Education Center
3939 Wisconsin Avenue
Washington, DC 20016

2630-103

Audio test panels made simple

By Bud Izen, CET/CSM

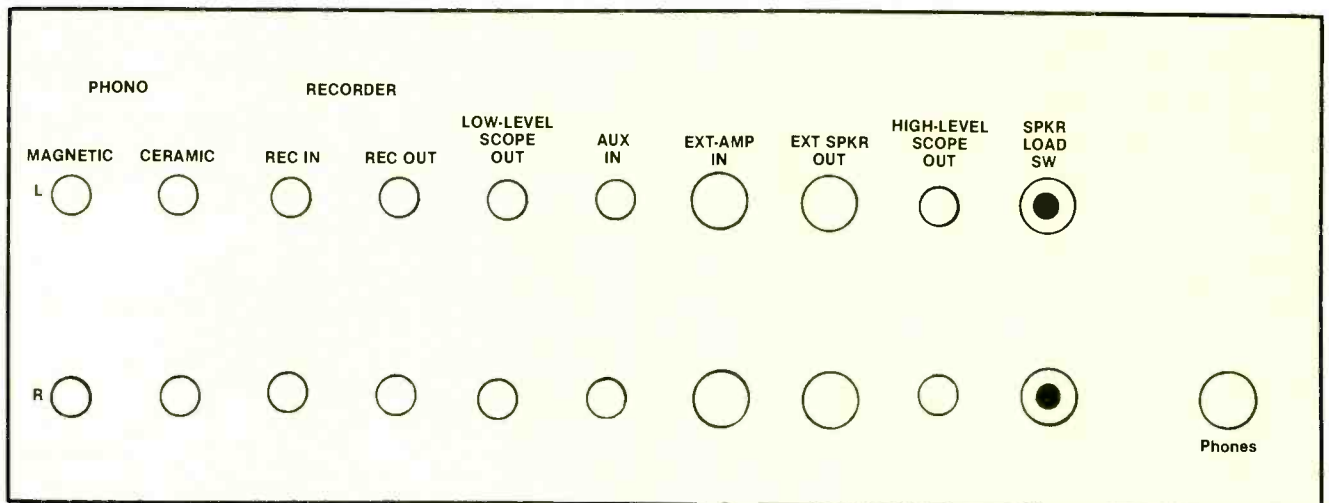

Many technicians, when faced with the thought of constructing an audio patch panel or test panel, cringe with fear and crawl away. In some cases, techs are even reluctant to start working on audio, for fear they may have to construct such an item. Their fears may not be groundless after seeing some of the wiring nightmares in use by other dealers.

Let me set your fears at ease. It is possible to construct a complete, versatile audio test panel without being an electrical engineer or a phone-company technician.

The following is a description of the test panel shown in Figure 1. There is nothing sacred or mandatory about this panel, other than the need to observe some basic grounding procedures. Change any or all of the parts, connections and switches as you see fit, as long as you keep track of the basic concept. The advantages of the recommended layout and switching arrangement are simplicity and freedom from the maze of wires and switches most of us associate with these panels.

The panel itself should be made

from non-conductive material, such as bakelite, in order to *avoid common grounds*. *Common grounding may cause problems* in the interaction of the equipment under test and your test receiver. Also, many manufacturers "float" the magnetic phono inputs from chassis ground in order to avoid similar difficulties. For lettering, stick-on or press-on decals are available from art stores and electronics stores that cater to hobbyists.

From the left (the lowest level signal) to the right (the highest level) the panel includes:

1. Magnetic phono inputs. Use single-conductor shielded wire for each channel. The best choice for a connection on the panel is an RCA jack, to mate with RCA plugs used on the connecting cables of a majority of turntables and changers. Terminate the cable running from the panel to the test receiver with a male RCA plug and plug it into the magnetic phono input or "phono low" input of the test receiver. Many newer receivers have only one input for all types of phono cartridges. If in doubt, plug

your test turntable directly into your test receiver before making any permanent connections.

2. Ceramic phono inputs. Use the same wiring as above, but connect to the high-level phono input. This set of inputs may be eliminated if your test receiver has only one set of inputs for all types of cartridges.

3. Recorder input. The same type of wire and connectors are used here. Cable from the panel should connect to *tape in*, *monitor in* or a similarly labelled connection on the test receiver. This input normally can be used to accept any high-level preamplified signal (about 1Vac), such as that from an equalizer, preamplifier or tuner.

4. Recorder output. This output uses the same type of wiring and plugs as above. It is used to provide a signal for use as an input for testing the record function of a tape deck or for high-level signal injection (about 1Vac) into another unit under test. The signal, taken from the *monitor out*, or *tape out*

OMNITRON:

OCTOBER SPECIALS

NOTE: Must Use "ETD" Part #'s For Special Prices

Silicon
H.V. Triplers

**HIGH VOLTAGE
MULTIPLIERS**



Original ECG **SYLVANIA Triplers**

ECG-500A

212-139
212-139-01
212-139-02
#ETD-20

\$10.99 ea.

ECG-523

212-141
212-141-01
#ETD-21

\$10.99 ea.

ECG-526A

212-141-02
212-141-03
212-141-04
#ETD-22

\$10.99 ea.

SANYO

TOSHIBA



2SC1308K
#ETD-5B

2SC1172B
#ETD-5C

\$1⁴⁹ /50 up
\$1.69 10-49

LCD 3 1/2 DIGIT DMM

Model 30B-140

\$39⁹⁵ #ETD-33

- 3 1/2" LCD display
- DC Input Impedance 10MΩ
- DC 100 V, 100mA, 0.1 ohm resolution
- DCA up to 10A
- Auto polarity

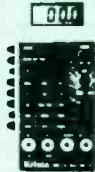

**6.5 MHz LABORATORY
OSCILLOSCOPE**

1 year warranty
— Very popular

\$174⁹⁵

#ETD-12
Model 31B-430

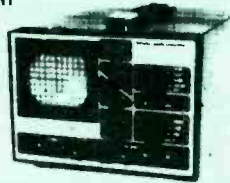

**JERROLD 60 CHANNEL
CORDLESS TV CONVERTER**
MODEL DRX-3-105

#ETD-100

\$89⁹⁵ ea.



BK PRECISION DYNASCAN CORPORATION Model 1476

10 MHz

dual trace
10mV/div
sensitivity
video sync
separators
includes
probes



#ETD-17 **\$435⁰⁰**
Reg. \$545⁰⁰

EICO 20 MHz DUAL TRACE SCOPE Model 482

Reg. \$799⁹⁵
Our Price

\$450.00 each

#ETD-19

Features:

- Dual Trace
- 5 mV/cm
- 5 mV/cm sensitivity.
- Automatic triggering.
- Add and subtract mode.
- Built in component tester.
- 17.5 nanosecond rise time.
- Includes 10:1/direct probes.
- Automatic selection of alternate or chop mode.



SPECIAL!

BK PRECISION DYNASCAN CORPORATION Model 1479B

30 MHz

#ETD-16
dual trace
5mV/div
sensitivity
10:1/reference/
direct probes
Included



\$635⁰⁰
REG. \$795⁰⁰

Xcelite #ETD-28 \$54⁰⁰

99 SM SERVICE MASTER TOOL KIT

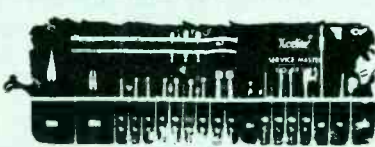

ECONO-LAMP #ETD-29



Model XL-334A
Our Price
\$14⁷⁵

MAGNIFIER LAMP



Model LUX-2A
Our Price
\$29⁹⁵
#ETD-30

WABER GROUNDED OUTLET STRIPS

- #207 BC - 6 outlets
- circuit breaker
- on/off switch
- pilot light



\$24⁹⁵ each
#ETD-31
#101AC - 4 outlet
version of 207BC
#ETD-32 **\$14⁹⁵**

SOLDER (60/40 Rosin Core)

1 lb. - .062 dia.

(regular size)

\$7⁹⁹

#ETD-2



1/2 lb. (thinner size)

\$3⁹⁹

#ETD-3

Weller All-Purpose Dual Heat Soldering Gun #ETD-23

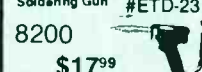

8200
Snap-Vacuum Solder Remover
KST-412 - Replacement Trips -
\$2⁹⁵ each #ETD-24
KSR-410 **\$4⁹⁹**

4 1/2" DIAGONAL CUTTING PLIER #ETD-25



#1934 **\$3⁹⁹**

3AG FUSE ASSORTMENT

#ETD-27

Model 3AG-300FK

300 pieces for

\$15⁰⁰



Assortment of 100 each, any value 3AG fuse, or 1-5A
Recommended Selection: 100 each of 2A, 3A & 5A fuses

#ETD-4 **99¢** SW-5
SOLDER WICK (Solder Removal) 1/8" (Thick Type)



**ADJUSTABLE-TEMPERATURE
SOLDERING STATION**

- Temperature 0°C to 750°C
- LED Indicators
- 50-B182- Replacement
Tips \$3.⁰⁰ each

Model 50B-180

\$49⁹⁵

#ETD-18

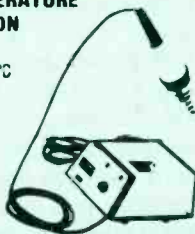

30 WATT ECONOMY SOLDERING IRON

Model FS-30

#ETD-35

\$1⁹⁹



25 WATT INDUSTRIAL GRADE

SOLDERING IRON

KST-252 Replacement

Tips... \$2⁹⁵ each

#ETD-36

Model KSI-25

\$7⁹⁹

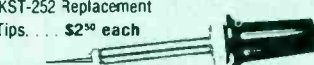

OMNITRON

ELECTRONICS

770 Amsterdam Ave., New York, NY 10025

■ Write for FREE 112 page Catalog ■

Send Purchase Order, Check, Money Order or C.O.D.

SHIPPING CHARGES

For Orders	ADD
\$25-100	\$6.50
\$100 - \$500	\$8.50
\$500 - \$750	\$10.50
\$750 - and up	\$15.00

PARCEL POST...\$20.00

or Call Toll Free 800-223-0826

in NY STATE (212) 865-5580

MASTER CARD • VISA

Circle (9) on Reply Card

or similarly labeled output on the test receiver, is unaffected by the volume or tone controls.

5. Low-level scope output. Using short, single-conductor shielded wire, this output is wired in parallel with the tape monitor output jack. It is present strictly for convenience so that the preamp signal can be easily monitored. This is especially useful for distortion detection and isolation testing.

With a dual-trace scope, the left channel can be compared to the right channel, and the preamp output can be compared to the power amp output. By adjusting the channel gain so that the size of one trace is the same as the other, the signals can be laid over one another. Any difference in the waveforms indicates distortion.

Use plugs on the test panel that are compatible with your scope, and make up two leads that will plug connect directly to the test panel and the scope for added convenience.

6. Auxiliary input. This input should be connected using the same wiring and plugs/jacks as in 1 through 4 above. This input will accept any high-level preamplified signal, such as that from an external tuner, preamp or tape deck. The cable from the test panel should be connected to the *aux. in* of the test receiver or a similarly labeled input.

7. External amplifier input. The use of this input allows an amplifier under test to be connected to the test speakers or the dummy load. Each of the jacks on the test panel should be a 2-circuit, normally-closed, standard 1/4-inch phone jack. Standard speaker wires (16 to 18 gauge) are run from the speaker output terminals of the test receiver to the normally-closed connection of the jack. The output side of the jack should be connected to the *speaker/load* switch (explained in 10 below). In this manner, when the connections from an amplifier

under test are connected, the speaker lines from the test receiver to the *speaker/load* switch are interrupted in favor of the amplifier under test.

Make up two additional cables out of speaker wire, each with a 1/4-inch phone plug on one end and bare wires on the other for connection to the amplifier under test.

8. Speaker outputs. This connection allows easy connection of the test receiver to the external speakers under test. The easiest way to wire this connection is to go directly from the second speaker output connections of the test receiver (which is why I suggested you buy a receiver with such an output). If the test receiver is so equipped, it is a simple matter to turn the switch on the test receiver to select the second set of speakers while disconnecting the first set. Otherwise, you will have to wire in switches that will interrupt the signal from the test receiver to the external amplifier input jacks. It is easier to buy the right receiver.

The jacks on the test panel should be 1/4-inch phone jacks. Make two connecting cords from speaker wire with 1/4-inch phone plugs on one end and bare wires on the other, or use the set made in step 7, because they are identical and unlikely to be used simultaneously.

Be sure to observe polarity on all speaker line runs to keep speakers in phase. Otherwise, excessive bass cancellation may result. In some cases it is possible that damage to the equipment also may occur. Under no circumstances should you ever use coaxial cable for speaker lines. This would present reactive load to the amplifier, causing loss of high frequency information, as well as amplifier damage in many cases (especially when testing high power amplifiers).

9. High-level oscilloscope outputs. Like the output described in 5 above, this is provided for convenience in measurement as previously described. Use speaker

wire, and observe phase as you wire this output in parallel with the input to the *speaker/load* switch. Use the same cables made for use in 5 above.

10. Speaker/load switch. This can be either two separate SPDT switches (as illustrated), or one DPDT switch. Make certain that no power is applied when switching, because a sudden open or transient can damage some types of output circuits (either solid-state or tube-type circuits are susceptible, especially high-powered ones). The input to this switch comes from the *external amplifier input* jack, as previously described.

Speaker grounds should be tied to one central point to avoid ground loops. Also avoid running speaker grounds through switches for similar reasons.

11. Headphone jack. This is optional and unnecessary if you have a test receiver that already has a headphone jack. If you choose to add one, the connections come from the *speaker/load switch* and connect to a stereo phone jack through a 470Ω, 2W resistor in each "hot" lead to prevent headphone burnout.

12. Turntable ground (not illustrated). To eliminate potential causes of 60Hz interference when turntables or changers are connected to the test panel, you should provide a ground connection. On the test panel, this can be done by providing a binding post near the magnetic phono input jacks. The binding post can be wired to the test receiver via a single piece of speaker wire. Then, when a turntable is placed under test, its ground wire (usually green) can be attached to the binding post.

There are more complicated designs than this, but few are more versatile and complete. The next article in the series will begin exploring the world of practical audio troubleshooting and supporting theory.

ES&T

The new N.A.P. Remote Control Cable Converter converts into new sales!



New 1983 Model CTC9R

Now there's the perfect product for your customers who're cable TV subscribers with "non-cable-ready" TV sets—the N.A.P. Cable Converter. Remote control and 60 channel capability are just two of the popular features available on this unique item.

- Remote control (mid-band & super-band capabilities).
- LED programmable clock for automatic on/off operation.
- Favorite station programming (skips over unassigned channels).
- Last channel recall (flips between two channels).

- Sequential scan in upward and downward directions.
- Off air antenna-VHF capabilities.
- Battery check light reduces unnecessary service calls.
- Remote control fine tuning.
- Limited 1 year warranty.

To start converting the N.A.P. Cable Converter into sales, contact your nearest N.A.P. distributor. Or if you're a direct dealer, get in touch with your N.A.P. parts center. Inquire about our full line of cable converters. It's a profit opportunity you'll want to tune into.



**CONSUMER
ELECTRONICS
CORP.**

N.A.P. Product Services, P.O. Box 309, Greeneville, TN 37743-0309/1-615-639-1121

A North American Philips Company

Circle (10) on Reply Card

Taking the mystery out of decibel calculations

By Sam Wilson, ISCET test director

Last month's article on decibels showed that the invention of logarithms simplified calculations of complicated mathematics problems. As it turns out, the response of the human eyes, ears and the other senses is logarithmic, so the decibel is an ideal way to evaluate human hearing. Because early amplifiers were used for audio reproduction, it was convenient to use the decibel to evaluate amplifier performance. The same idea carries over to video amplifiers.

Figure 1 shows a power amplifier with an input power of 0.005W and an output power of 1.2W. The decibel *gain* of this amplifier is a comparison of the input and output powers. Mathematically:

$$\text{dB gain} = 10 \log \frac{P_2}{P_1}$$

Where P_2 is the output power in watts, and P_1 is the input power in watts.

For the circuit of Figure 1:

$$\begin{aligned} \text{dB gain} &= 10 \log \frac{P_2}{P_1} \\ &= 10 \log \frac{1.2}{0.005} = 23.8 \end{aligned}$$

(To work this problem on your calculator, divide 1.2 by 0.005, then punch the *log* key and multiply by 10.)

I'm going to give an equation for calculating decibel gain when the input and output *voltages* are known and one for calculating decibel gain when the input and output *currents* are known.

These equations are often given in textbooks, but they are not useful equations. See if you can tell why as you follow their step-by-step development.

Before starting, remember an important rule for logarithms: To square a number, you can multiply its logarithm by 2, then take the antilog.

Consider the amplifier in Figure 2. The input and output voltages are given as V_1 and V_2 . The input and output resistances are both the same value and equal to R .

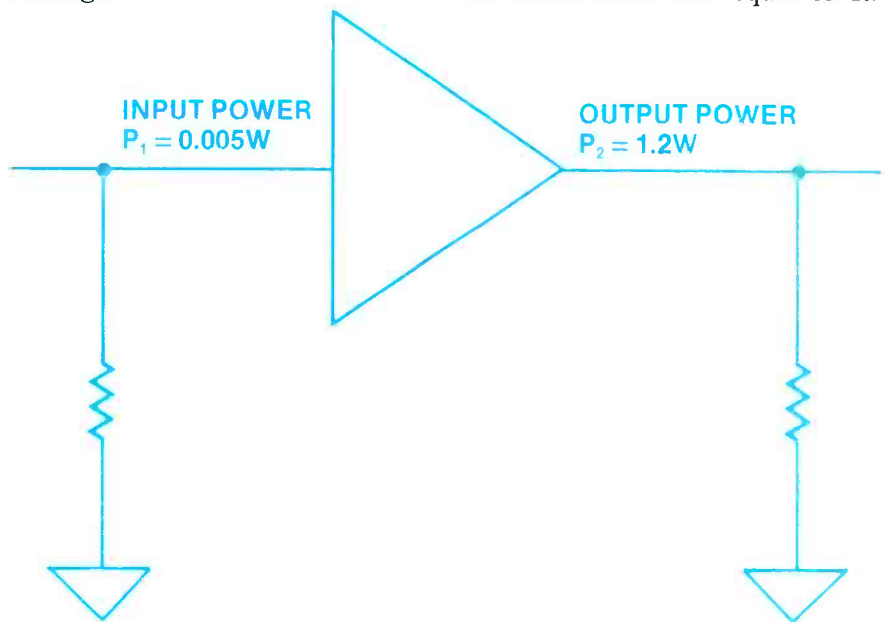

Figure 1.

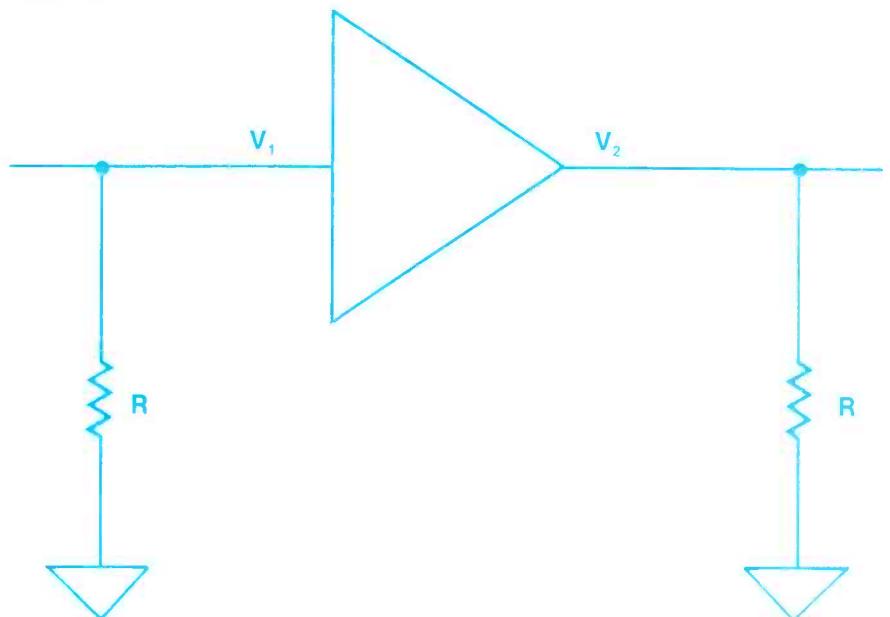

Figure 2.

Keep in mind the fact that power = V^2/R . So the decibel gain of the circuit of Figure 2 can be calculated by letting the output power (P_2) equal V_2^2/R and the input power (P_1) equal V_1^2/R .

$$\text{dB} = 10 \log \frac{P_2}{P_1}$$

but $P_2 = V_2^2/R$ and $P_1 = V_1^2/R$.

So, by substitution

$$\text{dB} = 10 \log \frac{V_2^2/R}{V_1^2/R}$$

The Rs cancel.

$$\text{dB} = 10 \log \frac{V_2^2}{V_1^2} = 10 \log \left(\frac{V_2}{V_1} \right)^2$$

To square a number, multiply its logarithm by 2, so

$$\text{dB} = 10 \times 2 \log \frac{V_2}{V_1}$$

or

$$\text{dB} = 20 \log \frac{V_2}{V_1}$$

In Figure 3, the input power is $I_1^2 R$ and the output power is $I_2^2 R$. If the input and output resistance values are equal:

$$\text{dB} = 20 \log \frac{I_2}{I_1}$$

You may have seen these equations before. Why are they practically useless? When is the last time you saw an amplifier with identical input and output resistances? Probably never. The equations are based on amplifiers that have the same input and output resistance values, and this is a condition that doesn't exist in practical circuits.

The equations for finding decibel gain when the resistance values and voltages (or currents) are known are given here. They are based on the more practical conditions shown in Figures 4a and 4b. The input and output resistance values are presumed to be different in those circuits. For the

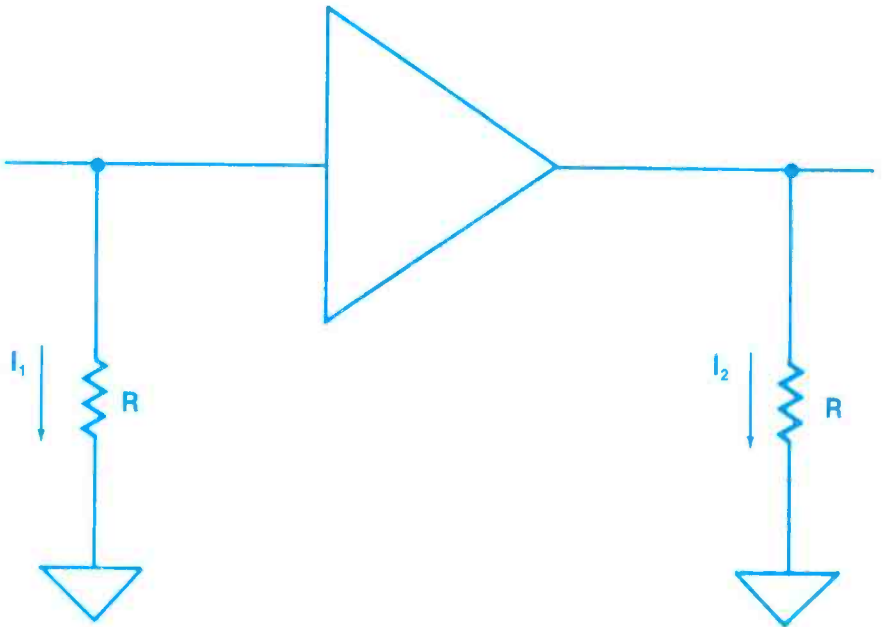

Figure 3.

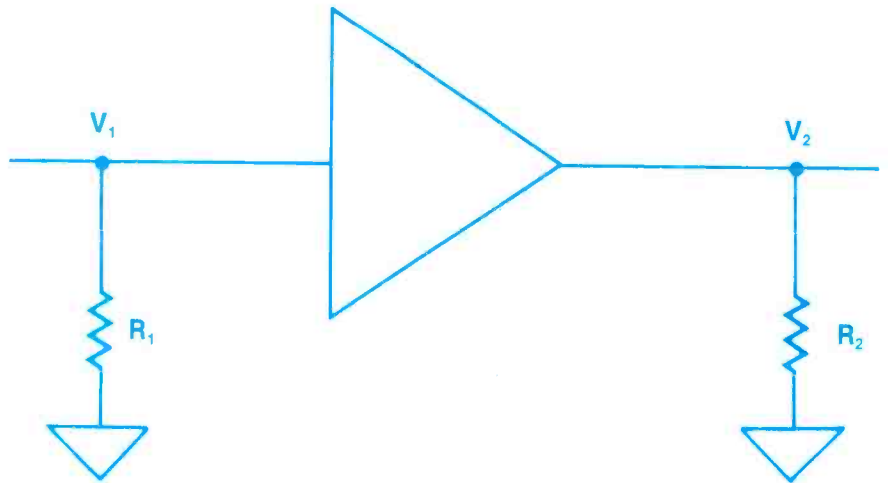

Figure 4a.

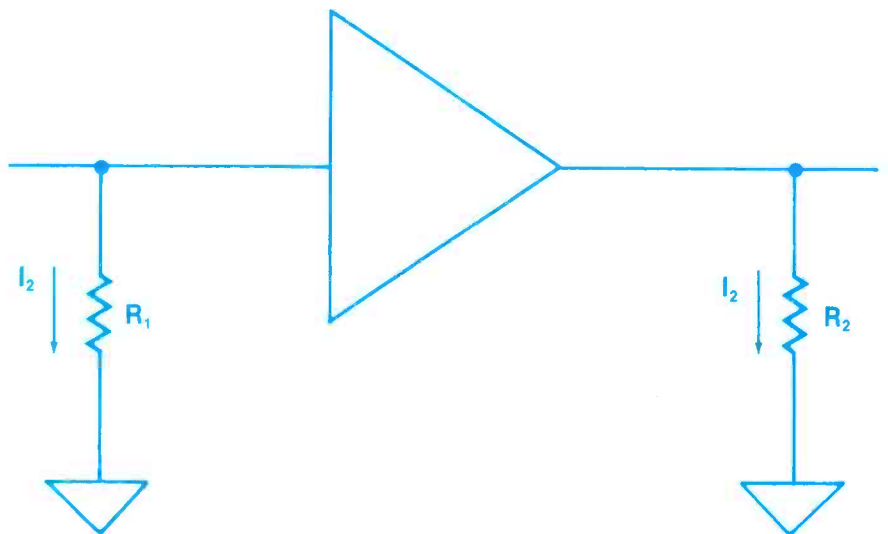
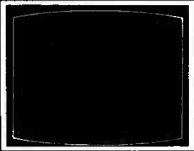
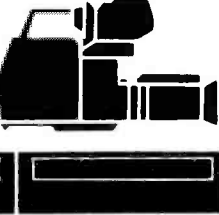



Figure 4b.

SPECIAL PUBLICATIONS NOW AVAILABLE FROM SONY!

- A collection of books on key concepts, in-depth theory of circuit operation and troubleshooting-aid for the following three categories of Sony products: AUDIO, BETAMAX, TV.
- The material is presented concisely. These books, although written for the average to advanced technicians, can be used as a self-help guide by anyone who is interested in Sony consumer products.

	MODEL & DESCRIPTION	PART NUMBER	PRICE	
	TV Products			
	Alpha-1 Chassis New Circuit Operation	2CTV480-2	\$5.00	
	Alpha-1 Chassis Troubleshooting Guide	2CTV1080-1	5.00	
	30P Chassis New Circuit Operation	2CTV681-1	7.00	
	30P Chassis Troubleshooting Guide	2CTV1181-1	7.00	
	Betamax Products			
	SL-5400 System Control and Troubleshooting Guide	2BETA180-1	\$3.00	
	SL-2500 New Circuit Operation	2BETA982-1	5.00	
	SL-5800 New Circuit Operation	2BETA681-1	3.00	
	AG-400 Auto Changer Circuit Operation	2BETA1182-1	3.00	
	HVC-2000 Circuit Operation	2CC1281-3	10.00	
	HVC-2400 Circuit Operation	T-999-714-31	5.00	
	Trinicon Color Cameras	2CC383-1	10.00	
	Audio Products			
	PS-X65, -X75 Circuit Operation and Troubleshooting Guide	2HF181-5	\$5.00	
	PS-X700, -X500, -LX5 Circuit Operation and Troubleshooting Guide	2HF1282-2	5.00	
	CRF-1 Theory of Operation	2HF1082-4	3.00	
	STR-VX6, -VX5, -VX4, -VX3, -VX2, -VX1 Circuit Operation	2HF1181-1	5.00	
	STR-V55, -V45, -V35, -V25 Circuit Operation	2HF481-2	5.00	
	ST-J75 Circuit Operation and Troubleshooting Guide	2HF781-4	5.00	
	RS-20 Circuit Operation	2HF782-1	3.00	
	PCM-F1 Troubleshooting Guide	9-959-013-11	3.00	
	CDP-101 Troubleshooting Guide	9-959-021-11	3.00	
		Miscellaneous		
		RF Interference Handbook	2TV990-1177-1	\$5.00
		Digital Electronics	2G183-1	8.00
Remote Control System		2RM383-1	3.00	

SONY®

TO ORDER: Send check or money order payable to "Sony Corporation of America" and mail to:
Sony National Parts Center, 8281 NW 107th Terrace, P.O. Box 20407, Kansas City, MO 64153

FOR FURTHER INFORMATION: Contact Lloyd Barningham,

Tel. (816) 891-7550

Circle (12) on Reply Card

October 1983 *Electronic Servicing & Technology* 25

condition in Figure 4a:

$$dB = 20 \log \frac{V_2}{V_1} + 10 \log \frac{R_1}{R_2}$$

For the condition in Figure 4b:

$$dB = 20 \log \frac{V_2}{V_1} + 10 \log \frac{I_2}{I_1}$$

It is doubtful if many technicians have memorized these special equations because *you really only need the equation for Figure 1 to solve any practical decibel problem.* The trick is to use the voltages and resistances (or currents and resistances) to calculate the input and output powers. Then plug the values of P_1 and P_2 into the equation and solve for decibel gain.

To calculate the decibel gain of the amplifier in Figure 5, first, calculate the input power.

$$P_1 = \frac{V_1^2}{R_1} = \frac{(0.175)^2}{1500} = 0.0000204W$$

Next, calculate the output power.

$$P_2 = \frac{V_2^2}{R_2} = \frac{(1.2)^2}{2500} = 0.000576W$$

Finally, calculate the dB gain.

$$dB = 10 \log \frac{P_2}{P_1}$$

$$= 10 \log \frac{0.000576}{0.0000204} = 14.5$$

You can save a lot of space if you use powers of 10 to simplify the numbers in this problem. However, because there are a lot of calculators that can't handle powers of 10 directly, I've used the basic numbers in this solution.

If you work the same problem using the equation for Figure 4a, you will get exactly the same answer.

So you only need one equation to solve decibel problems. The equation for Figure 1 can always be used if you first convert input and output values to powers.

To calculate the decibel gain for the amplifier in Figure 6, first, calculate the input power.

$$P_1 = I^2 R_1 = (0.022)^2 \times 6700 = 3.24W$$

Next, calculate the output power.

$$P_2 = \frac{V^2}{R} = \frac{(300)^2}{2500} = 36W$$

Now, calculate decibel gain using Equation 1.

$$dB = 10 \log \frac{36}{3.24} = 10.46dB$$

It isn't always necessary for the output power to be greater than the input power. If the input power is greater, use it for the numerator and assign a negative sign to your answer to show that there is a loss of power.

To calculate the decibel loss in the transmission line of Figure 7:

$$P_1 = 2410\mu W$$

$$P_2 = 1850\mu W$$

$$dB = -10 \log \frac{P_1}{P_2}$$

$$= -10 \log \frac{2410 \times 10^{-6}}{1850 \times 10^{-6}} = -1.148$$

The other type of logarithm

What do a baby, the voltage across a charging capacitor and a bean sprout have in common? They all grow (or increase) at a rate that is related to the constant δ (epsilon). This constant has an ap-

proximate value of 2.71828. On your scientific calculator and in many texts, it is written as e .

A complete book could be written about the theory and application of δ . In this article, we are only interested in the fact that it is used as a base for a complete system of logarithms.

The previous article explained that Napier invented logarithms and then Briggs made a suggested change. The original base used by Napier was δ . Briggs set up the system with base 10.

It really doesn't matter whether you use logarithms to the base 10 or base epsilon—the theory and procedure is the same: You manipulate the exponents of 10 or δ that are related to the base. Your calculator most likely uses \log to represent logs with a base 10 and \ln to represent numbers with a base δ . It is no surprise that there is an \ln equivalent to decibels (which are based on logarithms with a base 10.) The \ln equivalent is called the *Neper*.

$$\text{Nepers} = N_n = \frac{1}{2} \ln \frac{P_2}{P_1}$$

If you have a scientific calculator, you can easily solve this sample problem: A certain amplifier has an output power of 0.8W and an input power of 0.3W. Calculate the gain in decibels and in Nepers.

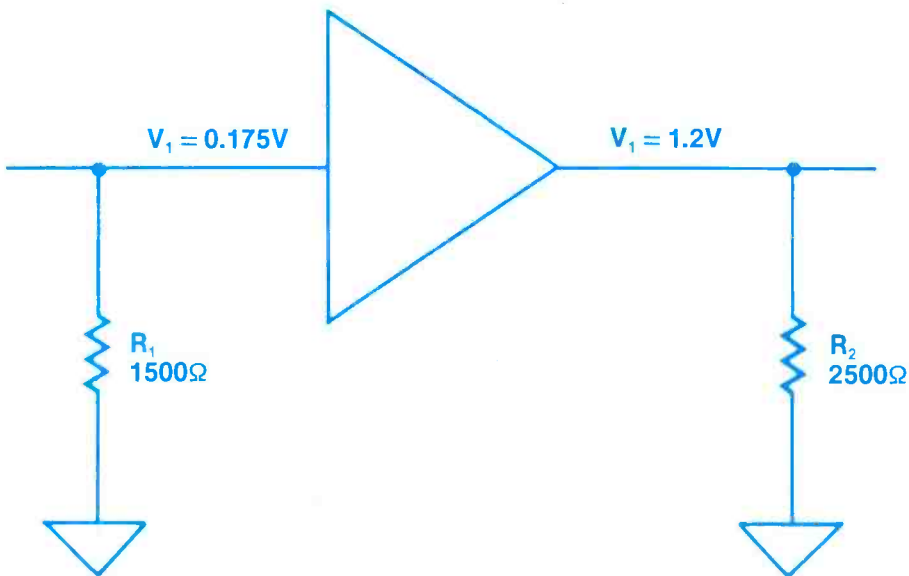

Figure 5.

FOUR GREAT REASONS TO USE N.A.P. FACTORY REBUILT MODULES.

1. ONLY N.A.P. rebuilt modules are always updated by our engineers to incorporate the most recent factory modifications.
2. ONLY N.A.P. guarantees genuine, factory approved replacement parts—pre-tested to exacting quality control standards before installation in modules.
3. ONLY N.A.P. provides modules tested to demanding factory quality assurance standards.
4. ONLY N.A.P. guarantees rebuilt modules that perform to rigid factory specifications. Our One-Year Warranty proves it.

Product Services Organization
P.O. Box 555, Dept. 741
Jefferson City, TN 37760
1-615-475-3801, Ext. 7348



**PRODUCT
SERVICES
ORGANIZATION**

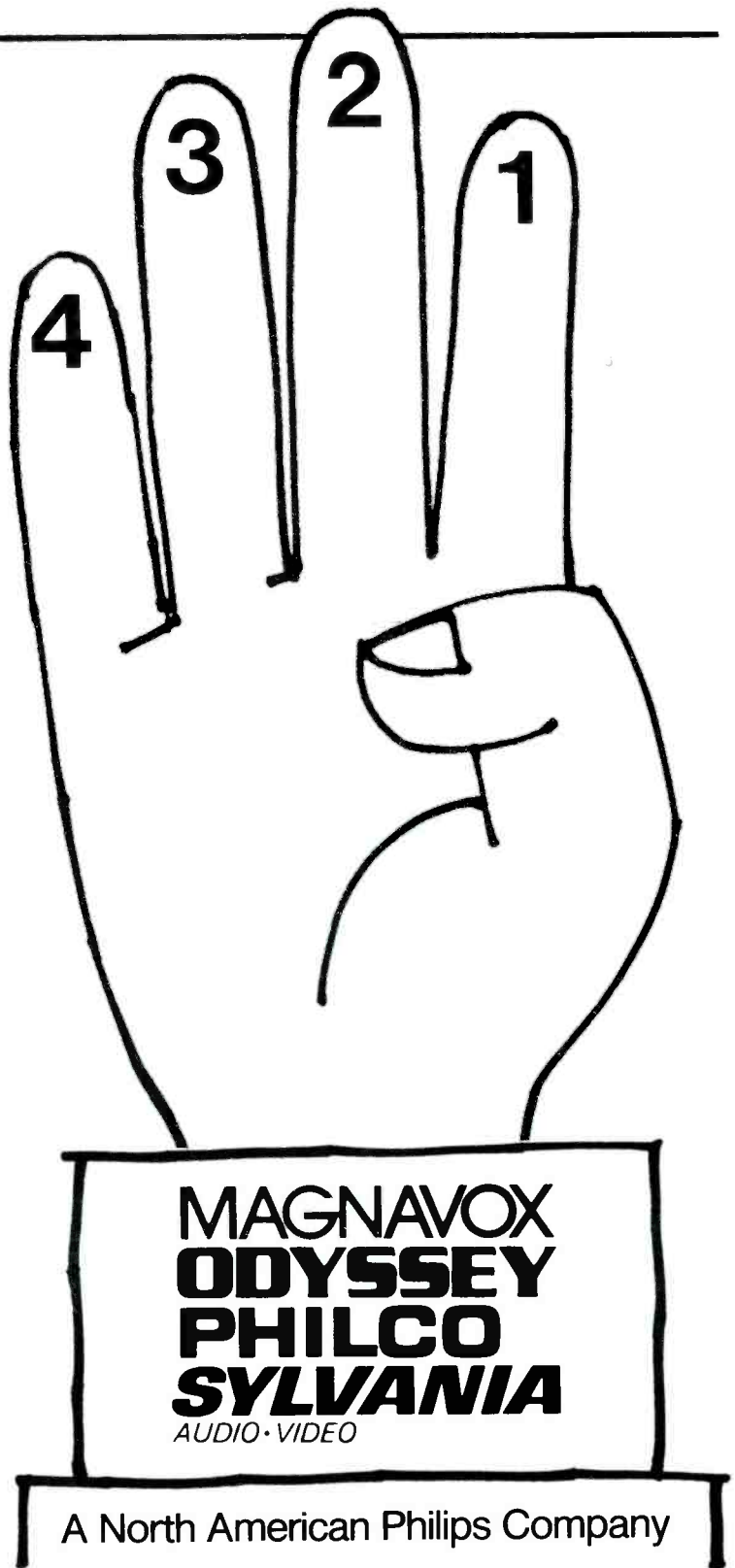

Circle (13) on Reply Card

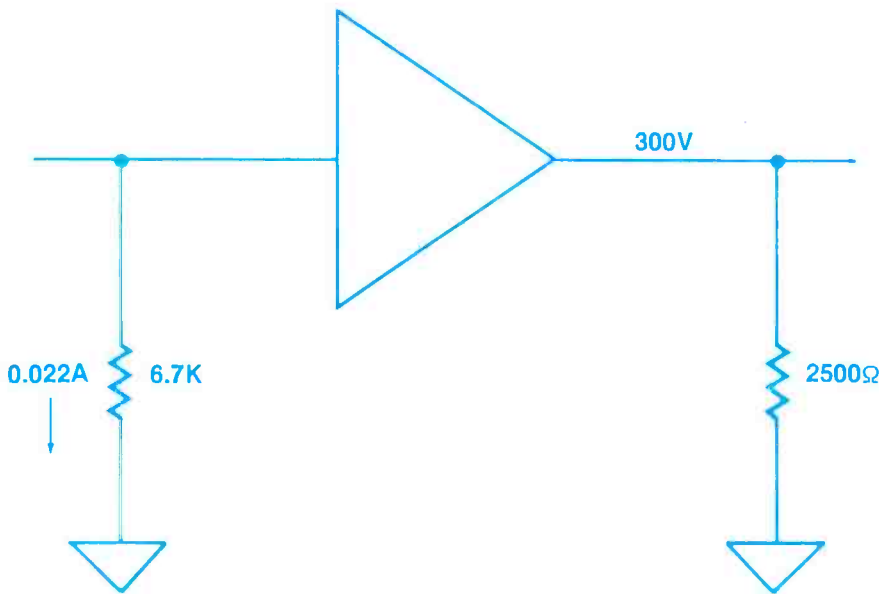

Figure 6.



Figure 7.

Solution:

$$\text{dB} = 10 \log \frac{P_2}{P_1}$$

$$= 10 \log \frac{0.8}{0.3} = 4.26$$

$$N_n = \frac{1}{2} \ln \frac{P_2}{P_1} = \frac{1}{2} \ln \frac{0.8}{0.3} = 0.49$$

As with decibels, you can solve problems in gain with voltage or current by first converting the input and output values to power.

An interesting equation relates decibels and Nepers:

$$\text{Nepers} \times 8.686 = \text{dB}$$

Because of this direct relationship, you can assume that everything that has been said about the logarithmic response of the eye and ear applies regardless of which system is used. **ES&T**

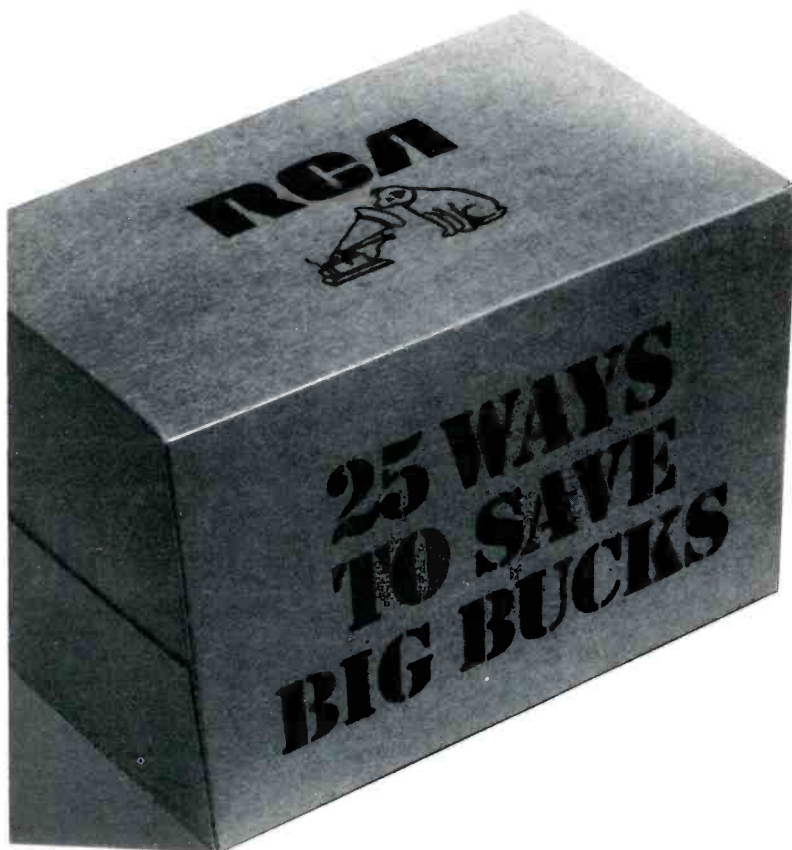

RCA's new VCR Parts Package.

RCA's newest Parts Package holds the 25 fastest-moving VCR parts you'll need for servicing RCA and other brands of VCRs.

And it's priced to save you money.

The whole package sells for less than the total cost of the individual parts. You get all 25 mechanical and electrical parts with one convenient order.

For full information, see your RCA Parts Distributor. Also ask him for the RCA VCR Parts Cross Reference (Form 1F6627) and VCR Tool Catalog (Form 1F6857).

RCA Distributor and Special Products Division

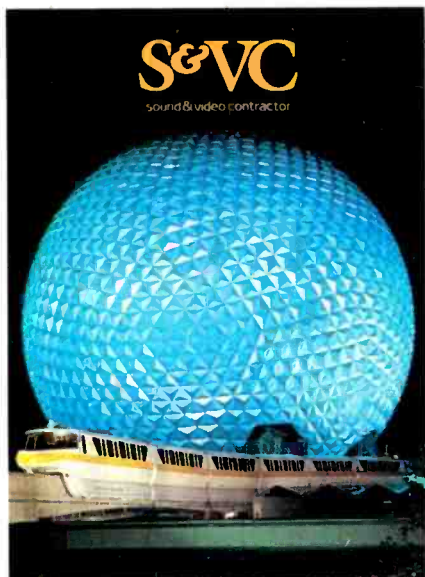

Introducing...

S&VC

sound & video contractor

You can receive **FREE**
a new magazine exclusively for
sound and video contractors
and related industry professionals.

S&VC covers the entire realm of sound and video contracting. It's the only monthly publication that provides in-depth information on business operation and management as well as technology updates—all in one well-designed, colorful, easy-to-read format.

If you're a...

- Contractor • Consultant • Electrical Engineer • Distributor/Dealer • Wholesaler

...then S&VC is for you.

And if you design...specify...purchase...install...or service any of the following systems, you need to be reading S&VC:

- Security
- Fire/Burglar Alarm
- Life Safety
- Closed Circuit TV
- Cable TV
- Intercom
- Public Address
- Concert Sound
- Sound Reinforcement
- Sound Masking
- Paging
- Pro Sound
- Engineered Sound
- Telephone/PBX

Every month S&VC keeps you abreast of the latest equipment innovations. Teaches you how to advertise and market your company. Explores the newest industry trends. Explains the latest industry regulations and codes. Provides tips on installing and servicing equipment. Remember, S&VC is sent absolutely free to all qualified sound and video contracting and related industry professionals. To receive your free copy of S&VC, simply complete and return the coupon below. We'll promptly mail you a subscription card.

S&VC
sound & video contractor

**you can't afford
not to read it.**

YES!

Send me my **free**
Subscription to S&VC

Mail to:

Ingrid Busch
Subscription Dept.
S&VC
P.O. Box 12901
Overland Park, KS 66212

Name _____ Title _____

Company _____

Address _____

City _____ State _____ Zip Code _____

ESX

Troubleshooting Tips

Blown line fuse General Electric 25YM

(Photofact 1780-1)

As I checked this color receiver in the customer's home, I found the line fuse (F1201 2.5A slow-blow type) was blown. A breaker of suitable amperage was substituted, but it tripped when the power was applied.

While I was testing the power supply for a short, I turned the customer's dimmer control to give more light from the table lamp. When I next applied power to the receiver, it operated correctly.

After some investigation, I found the customer had plugged the TV cable into the lamp-dimmer outlet. After the TV plug was changed to a direct wall outlet, a replacement fuse brought back normal operation.

After some thought, I realized that pulsed-voltage light dimmers (using triacs or SCRs as choppers) never should be used with any electronic equipment having line-rectified dc-voltage power supplies. The 25YM General Electric color receiver has a power transformer that regulates the secondary voltages

by current saturation. Probably the overload that blew the fuse was the strong current surge through C1207 (3.5µF capacitor across the transformer secondary) produced as the dimmer abruptly switched on (with very fast rise time) when the instantaneous voltage during each cycle was near maximum amplitude.

Remember, do not use a triac or SCR dimmer to supply input ac line voltage to any electronic equipment, although the results seldom will be as severe as stated for this case. If the line voltage must be reduced, use a variable-voltage transformer.

Frank Fligel
Berwyn, IL

Horizontal could not be locked General Electric EC-A

(Photofact 1918-1)

After checking IC501 countdown IC voltages and waveforms without finding anything suspicious, I concluded IC501 was defective. However, the horizontal could not be locked after it was replaced.

While making additional scope tests around IC501, I noticed that the positive end of C520 had a mixture of vertical and horizontal waveforms. This hinted that a defect here might affect the horizontal locking, because pin 2 and C520 are part of the automatic-phase-and-frequency-control (AFPC) circuit. Tests of all components around that area showed excessive leakage in C520, and the horizontal locked correctly after C520 (1µF) was replaced.

This repair made me remember the reason

OPTIMA ELECTRONICS

TO ORDER CALL TOLL FREE 1-800-327-0224
G.E., SYLVANIA, ZENITH, RCA, 75% OFF LIST NEW-BOXED

<input type="checkbox"/> 3A3	5 FOR \$15.75	<input type="checkbox"/> 6LF6	5 FOR \$34.44
<input type="checkbox"/> 6MJ6	5 FOR \$34.88	<input type="checkbox"/> 6LB6	5 FOR \$31.50
<input type="checkbox"/> 6JE6	5 FOR \$32.75	<input type="checkbox"/> 6CJ3	5 FOR \$14.69
<input type="checkbox"/> 3DJ3	5 FOR \$17.44	<input type="checkbox"/> 6JS6	5 FOR \$29.00
<input type="checkbox"/> 6GH8	5 FOR \$12.44	<input type="checkbox"/> 6BL8	5 FOR \$12.25

All Tubes Not Advertised, Write In at 75% Off List.
Sleeves Only, Singles 72% Off List

HORIZONTAL OUTPUT TRANSISTORS		REPLACEMENT TRIPLERS	
<input type="checkbox"/> RKS1172B	<input type="checkbox"/> RKS238	<input type="checkbox"/> 500A .. \$11.75	<input type="checkbox"/> 526A .. \$14.95
<input type="checkbox"/> RKS1308K	<input type="checkbox"/> RKS165	<input type="checkbox"/> 523 .. \$13.95	<input type="checkbox"/> 529 .. \$15.50

TRANSISTORS & I.C.'S...MIN. 10, CAN MIX

T.V. #'s	Pop. I.C.'s	STEREO #'s
<input type="checkbox"/> 2SC1114 .. \$3.75	<input type="checkbox"/> 712 .. \$1.40	<input type="checkbox"/> DM133 .. \$5.95
<input type="checkbox"/> MN8303 .. \$3.95	<input type="checkbox"/> 713 .. \$1.40	<input type="checkbox"/> DA101 .. \$5.75
<input type="checkbox"/> 2SC1034 .. \$5.95	<input type="checkbox"/> 714 .. \$1.50	<input type="checkbox"/> HA1377A .. \$3.25
<input type="checkbox"/> 2SC867A .. \$3.50	<input type="checkbox"/> 731 .. \$1.50	<input type="checkbox"/> HA1388 .. \$5.25
<input type="checkbox"/> 2SD870 .. \$4.75	<input type="checkbox"/> 790 .. \$1.50	<input type="checkbox"/> HA1396 .. \$5.50
<input type="checkbox"/> 2SD871 .. \$5.50	<input type="checkbox"/> 791 .. \$1.95	<input type="checkbox"/> HA1398 .. \$4.95
<input type="checkbox"/> AN5210 .. \$6.50	<input type="checkbox"/> 792 .. \$2.00	<input type="checkbox"/> UPC1181 .. \$1.25
<input type="checkbox"/> AN5310 .. \$3.95	<input type="checkbox"/> 793 .. \$2.00	<input type="checkbox"/> UPC1182 .. \$1.25
<input type="checkbox"/> AN5320 .. \$3.25	<input type="checkbox"/> 819 .. \$1.50	<input type="checkbox"/> UPC1185H .. \$2.95
<input type="checkbox"/> AN5435 .. \$2.95	<input type="checkbox"/> 820 .. \$2.00	<input type="checkbox"/> UPC1367 .. \$3.25
<input type="checkbox"/> LM1818 .. \$3.25	<input type="checkbox"/> 821 .. \$2.25	<input type="checkbox"/> UPC1368H2 .. \$3.95

GENERAL

<input type="checkbox"/> 25 ft. Modular Plug Curly Cord (B&W) ..	10 for \$22.50
<input type="checkbox"/> Pop. HI DIV-3...focus block divider ..	10 for \$35.00
<input type="checkbox"/> 6 ft. Cheater Cords SPT2 ..	10 for \$ 7.95
(Heavy Duty - UL App. 7 Amp. 125V. P & NP)	
<input type="checkbox"/> 6 ft. Cheater Cords SPT1 ..	25 for \$13.75
<input type="checkbox"/> BSR Changers ..	\$33.95
<input type="checkbox"/> Replacement Tone Arms (mono & stereo) ..	5 for \$6.00

ATARI GAME CHIPS:

<input type="checkbox"/> Voltage Regulator ..	\$.95
<input type="checkbox"/> CPU ..	\$ 4.95
<input type="checkbox"/> RAM/I/O ..	\$ 6.50

Quantity Prices Available
Letters of credit and all checks placed on deposit with Bank of Hallendale, FL. VISA & Master Charge accepted. Min. order \$75. FOB Dania, FL. Catalog \$3, refundable upon order.

**SEND CHECK OR MONEY ORDER TO:
OPTIMA ELECTRONICS
2022 Tigertail Blvd., Dania, FL 33004
Phone (305) 920-3550 TOLL FREE: 1-800-327-0224**

TECHNICIANS & SERVICEMEN

COMPONENTS FOR YOUR MAINTENANCE & REPAIR WORK

SPECIAL: OUR LOW LOW PRICES

REPLACEMENT FOR ECG® TYPES

TYPE NO.	YOUR COST	TYPE NO.	YOUR COST
85	FOUR for .99	125	SEVEN for .99
102A	THREE for .99	159AP	FOUR for .99
123A	FIVE for .99	177	EIGHT for .99
123AP	SIX for .99	199	FIVE for .99

SUPER SPECIAL (MIN. 5 PC. EACH)

TYPE NO.	YOUR COST	TYPE NO.	YOUR COST	TYPE NO.	YOUR COST
12485	165	2.25	37590
12845	17165	50655
12945	18445	500A	8.95
13080	18545	523	9.95
15240	238	2.25	526A	10.20
15340	276	6.95	529	13.75
15460	29195	712	1.25

JAPANESE TYPES (MIN. 5 PC. EACH)

2SC867A	2.75	HA1366W	1.85	STK0029	3.80
2SC1114	3.25	HA1377A	2.90	STK0080	9.99
2SC1308K	1.95	LA4102	1.25	TA7205AP	1.50
AN214Q	1.45	M51515BL	2.95	TA7208P	1.85
AN239A	4.60	STK433	3.95	TA7222AP	1.95
BA532	1.80	STK435	3.95	UPC1181H	1.25
GH3F89	STK437	6.25	UPC1182H	1.25
HA1342A	2.30	STK439	6.50	UPC1185H	2.99

COD ORDERS WELCOME (\$25 MIN. ORDER)

For Complete Component Catalog Call or Write
DIGITRON ELECTRONIC
110 HILLSIDE AVENUE, SPRINGFIELD, N. J. 07081
Toll Free: 800-526-4928 In NJ: 201-379-9016

*ECG IS A TRADE MARK OF PHILIPS ECG
DIGITRON ELECTRONIC IS NOT ASSOCIATED IN ANY WAY WITH PHILIPS ECG.

Circle (15) on Reply Card

Circle (16) on Reply Card

YOU SELECT FULL MANUAL
OR FULL AUTORANGING

500 HOUR BATTERY LIFE

HIGH CONTRAST LCD
SHOWS MEASUREMENT
AND FUNCTION

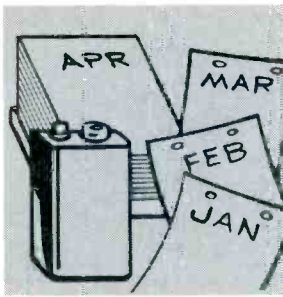

0.25% dc volt
accuracy
Continuity beeper
Diode test
Transient and
overload protected
High energy fuse

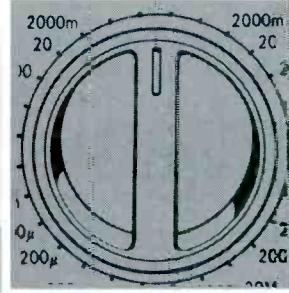
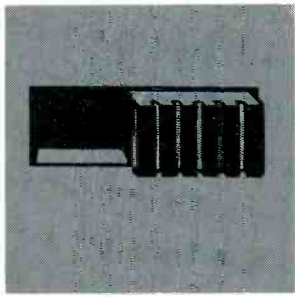

EASY TO USE... RELIABLE
SINGLE-ROTARY
CONTROL SWITCH

OTHER NEW
DMM MODELS
PRICED
FROM
\$75.00

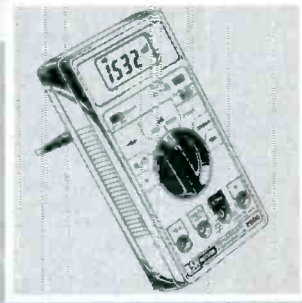

New! A digital multimeter that lets you choose autoranging convenience or manual control

MODEL 2816
\$150.00

To learn more about the 2816
and the complete line of new B&K-PRECISION
DMMs, see your local distributor or call
[1 312 889-9087].

BK PRECISION DYNASCAN
CORPORATION

6460 West Cortland Street • Chicago, Illinois 60635 • 312/389-9087

International Sales, 6460 W. Cortland St., Chicago, Illinois 60635
• Canadian Sales, Atlas Electronics, Ontario
South and Central American Sales, Empire Exporters, Plainview, NY 11803

FINALLY. COMPUTERS AS A NEW TOOL FOR T.V. REPAIR.



Primefax puts computer-assisted repair capability in your shop today.

Primefax drastically reduces the number of sets requiring extensive trouble-shooting procedures.

Through the use of today's technology, Primefax maintains—in a central computer—a database of problem-solving solutions for television set malfunctions.

Primefax is a compilation of the most current, applicable technical information acquired from hundreds of valuable sources... and updated daily.

With a Primefax Computer Terminal installed in your shop, you can do your job more quickly and more

accurately. You have more satisfied customers, and your profits are increased substantially.

Reduced call backs • faster turn-around • reduced chance of repeated failure • more thorough service and complete repair at reasonable cost.

The more Primefax is used, the more profit you realize.

CALL US OR WRITE. No matter how you compute it, Primefax means profit for you. It's worth looking into.

In Texas, call (512) 344-5999 • Ou. of Texas, call 800-531-5953



4825 Fredericksburg Road • San Antonio, Texas 78229

Circle (18) on Reply Card

Quick charge cordless soldering iron. Up to 125 electronics joints per charge. Total recharge in less than 4 hours. Isolated tip design. One of more than 2 dozen ISO-TIP and ORYX irons available. Write for free catalog and name of nearest distributor.

A Hot Tip on Cordless Soldering

No. 7700
QUICK CHARGE
Cordless
Soldering Iron

ISO-TIP®
ORYX®

WAHL CLIPPER CORPORATION
Sterling, Illinois 61081 • (815) 625-6525

Circle (19) on Reply Card

several of these components were added to the horizontal circuit. They are included to speed up the AFPC operation during the vertical interval (including retrace), and the speed-up removes most of the skew errors when the receiver is showing pictures from a videocassette recorder (VCR). A

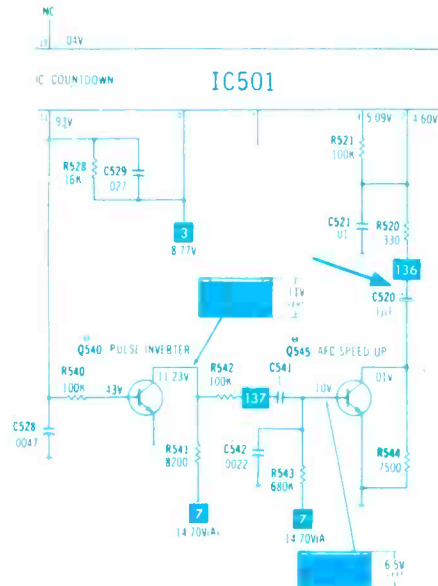

positive-going vertical pulse from IC501 pin 11 is inverted by transistor Q540 and applied through a large-value resistor and capacitor series circuit to the Q545 base. These negative-going vertical pulses at the Q545 base apply reverse bias to Q545 during vertical-interval time, while the positive voltage through R543 applies saturation bias to Q545 at all other times. When Q545 has saturation bias, its collector-to-emitter path is almost a short circuit that shorts across resistor R544, removing it from the circuit.

In other words, when Q545 is not conducting during vertical-sweep time, the time constant between pin 2 (where the dc AFPC control voltage is found) and ground is the sum of R544 and R520 vs. C520. When Q545 conducts during retrace time, R544 is shorted across, changing the time constant to 330Ω R520 and 1μF C520. Therefore, the charging and discharging of C520 is speeded up so the locking can follow the VCR variations properly. However, leakage in C520 reduces the AFPC dc control voltage, preventing any horizontal locking.

L.K. Bellinger
Kalamazoo, MI

Has a squeal but no picture RCA CTC108C

(Photofact 2030-2)

When first powered-up on the service bench, the RCA CTC108-chassis color receiver produced a squealing noise but no raster. I tested the main power supply, the SCR regulator circuit and the resistances of the T402 flyback transformer, but found no obvious defects. Replacement of the flyback did not change the symptoms.

Tests of dc voltages in the horizontal-sweep circuit located a voltage of only +5V at the collector of Q411, the horizontal-driver transistor. Normal voltage is about +80V to +85V, so this reading

proved the problem must be near the driver stage.

I couldn't find any problems in the driver stage, so I checked back to the protection circuitry. Resistance measurements finally identified an open R436. This open resistor upset the delicate voltage balance in the protection circuitry, triggering Q413 and Q414. These transistors form a locking switch when they are activated, and the switching applies an excessive voltage to the Q411 base. Q411 is saturated, reducing its collector voltage to almost zero and eliminating all gain in the driver stage, which killed the horizontal sweep. This circuit action is called *shutdown*.

After I replaced R436, the receiver went through normal start-up and produced a good picture.

Andrew Jack
Moundville, AL

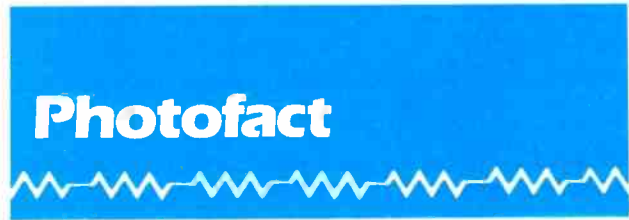

These Photofact folders for TV receivers have been released by Howard W. Sams & Co. since the last report in ES&T.

AOC	
Chassis M9C1-5B6, M9C3-5B3	2187-1
Chassis M3C2-1B2	2188-1
Chassis M9C1-1B/1B4/1B5, M9C3-1B/1B1	2189-1
Chassis M3C2-5B	2191-1
MAGNAVOX	
Chassis E51-56	2189-2
REALISTIC	
16-105	2190-1
16-102	2193-1
SAMPO	
Chassis C3-19D	2192-1
SEARS	
564.48620150/8620151/8620152/ 8670150/8670151/8670152/ 8720150/8720151/8720152	2187-2
564.42371250/51	2188-2
562.42181250	2190-2
401.50230150/51	2191-2
SONY	
Chassis SCC-406A-A,B-A	2180-2
SYLVANIA	
Chassis E34-11/12/13	2181-1
Chassis E34-18/19/32/33	2183-1
Chassis UXC	2191-3
TOSHIBA	
Chassis TAC113/114/163/164	2181-2
Chassis TAC8101/151	2183-2
ZENITH	
Y1960P/970P/992E	2192-2
SY1961W,X/963W,W77/973P/993W	2193-2

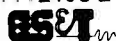

*"If it's not a GE, I think
I'll just stay in the truck."*

In this business, you never know what you'll run into. So it's always nice to run into a GE color TV, packed with its own Mini-Manual, including a schematic, parts list and troubleshooting guide. Since 1977 we've put a Mini-Manual inside every color set we make. Look for it every time that you're servicing a GE color TV. And use our toll-free numbers for parts orders and technical assistance. You'll have a good reception the next time your GE customer needs service.



We bring good things to life.

GENERAL  ELECTRIC

INTRODUCING

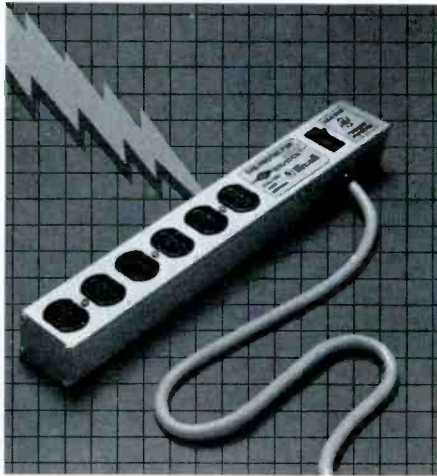

THE PROTECTOR 6000™

TOTAL PROTECTION FOR YOUR SENSITIVE ELECTRONIC EQUIPMENT.

Something that you can't even see may be slowly but surely killing your expensive electronic equipment. It's transient voltage, and it can be fatal to computers, medical equipment, electronic games, videotape recorders, electronic test equipment, electronic cash registers — almost any of today's sophisticated solid state equipment.

THE TRANSIENT VOLTAGE PROBLEM.

Most of this modern electronic equipment uses LSI and MOS semiconductor devices which are extremely sensitive to voltage transient surges or "glitches." In fact, a large percentage of equipment failures can be directly linked to the damaging effects of over-voltage line transients to unprotected, highly fragile components.

THE PROTECTOR 6000™ SOLUTION.

Not to be confused with other transient voltage protection units available today, THE PROTECTOR 6000 uses state-of-the-art solid state components and exclusive circuitry to provide you with complete and total protection from transient voltage surges of up to 6,000 volts. THE PROTECTOR 6000 uses silicon PN junction devices — proven to provide the fastest response to surges! They have a statistical life expectancy of over 20 years. THE PROTECTOR 6000 has a maximum clamping voltage of only 335 volts, well below the voltage rating of other transient protection devices which commonly use much less effective MOV's or gas discharge tubes. It also provides full protection from electro-magnetic and radio frequency interference. The unit operates in both common and differential modes, and is outfitted with a circuit breaker to guard against severe current overloads over 15 amps.

Why take chances with your expensive electronic equipment? For full details contact your local NTE distributor or write:



NEW-TONE ELECTRONICS, INC.
44 Farrand St., Bloomfield, NJ 07003
THE PEOPLE WHO BRING YOU THE TCG
LINE OF SEMICONDUCTORS.

© 1983 New-Tone Electronics, Inc.

Readers' Exchange

Needed: Sony color CRT 470KXB22 escutcheon (front panel) for Sony color KV-1743R and escutcheon for b/w Panasonic TR-579. Send price by post card. Also need Sams 1225, 1273, 1335, 1371, 1382, 1392, 1497, 1505, 1509, 1522, 1681, 1723, 1742, 1881, 1902. *Frederick Jones, 407 Morningbird Court, Niceville, FL 32578.*

Needed: Supremes Vol. R-7 and TV-1 through 4. *C. T. Huth, 146 Schonhardt St., Tiffin, OH 44883.*

Needed: Service manual and schematic for pulsar diagnostic scope, model 500, made by Peerless Instrument Company, *Loran D. Bailey, 2792 E. 71st, Indianapolis, IN 46220.*

Needed: New or good used 15GP22 picture tube. *Alan R. Betz, Box 3292, Blaine, WA 98230.*

Needed: Schematic, service manual and operation instructions for Hammarlund HQ 110. Will buy or copy and return. *Headley E. Hanson, 301 McClellan Ave., Mt. Vernon, NY 10553.*

Needed: Sencore LC53-Z meter. *Nate Lilienthal, 29515 Quailwood Drive, Rancho Palos Verdes, CA 90274; 213-877-9913.*

Needed: Manuals on b/w and color televisions (theory, diagnosis and servicing). *James E. Gregorich, 117 2nd St., N., Virginia, MN 55792; 218-749-4355.*

Needed: Hickok 209 meter. Have RCA or Zenith modules for trade; willing to pay cash if price is right. *George Payad, Payad Radio TV, 125 E. Main St., Staunton, IL 62088; 618-635-2111.*

Needed: Operating manuals and schematics for Precise oscilloscope M/N 315 (or 3151) S/N 1617, made in Oceanside, NY. Also Knight capacitor checker (has one indicator eye and three switches but no M/N or S/N). Will buy but would prefer to copy and return. *Val Fogle, 175 Millstream Drive, Huntsville, AL 35806; 205-453-2819.*

Needed: Used Grantham College electronics correspondence A.S.E.T. program and Atari TV games service manuals (not available in South Africa). I am a CET and ETA member in TV broadcasting maintenance and would like to correspond with other technicians. *Kantilal Ramjee, 41 Agapanthos Road, Malabar, Port Elizabeth 6016, South Africa.*

Needed: Instruction manual and schematic for EICO model 427 oscilloscope, stock #89282. Will buy or copy and return. *John A. Black, 1016 E. North Ave., Lompoc, CA 93436.*

Needed: Instruction manual and/or any other data for GC Electronics tube tester and CRT reactivator, model #36-540. Will buy or copy and return. *Al Wysocki Jr., 384 Main St., Sayreville, NJ 08872.*

Needed: Tentelometer model T2-H7-UM or T2-H15-UM or similar videotape tension gauge. State condition and price. *R.M. Query, 6346 King Louis Drive, Alexandria, VA 22312; 703-354-3721.*

Needed: Counterbalance weight assembly and bias compensator for model SL95B Garrard turntable. State price. *D. F. Mordant, P.O. Box 1776, Hickory, NC 28603.*

For sale: Heathkit model HD-1250 solid-state DIP meter, \$50; Mercury model 1000 dynamic transconductance tube tester, \$25; Conar model 202 frequency counter, \$20. *William Shevtchuk, 1 Lois Ave., Clifton, NJ 07014; 201-471-3798.*

For sale: Sams Photofact folders 1676-2053 complete, \$2 each. Also 150 miscellaneous folders from 1000-1676, \$1.50 each. *James R. Ince, Route 2, Box 67, Milton-Freewater, OR 97862.*

For sale: Complete Heathkit digital course EE-3201 with trainer ET-3200A. Best offer over \$100 plus shipping. Also have Sams 2-1309 with cabinets. *Robert Knapp, P.O. Box 145, Lyndhurst, VA 22952.*

For sale: Sams Photofacts 66-1185, \$1000. Four cabinets included. B&K model 415 IF alignment generator, \$225. B&K bar-dot-crosshatch generator, model 1242, usable but may need cleanup, \$45. *Terrick TV, 809 Amity St., Homestead, PA 15120.*

For sale: Cutting back on color TV servicing; selling test equipment. Send large SASE for list. *Maurer TV Service, 29 S. 4th St., Lebanon, PA 17042.*

For sale: Conar model 455 6MHz scope, \$100; Fluke model 8020A DMM with case and probes, \$90; Castle Mark IV tuner subber, \$45. *Jim Malone, 5111 Bagnall, Jefferson City, MO 65101; 314-893-5069.*

For sale: Sams Photofacts 300-1000, \$1 each; an assortment of older car radios, \$10 each; B&K 415 sweep marker, \$200. *R. L. Nistor, Globe TV, 3407 Arlington Ave., Riverside, CA 92506.*

For sale: 200 two-way, 80W crossover network, \$700. *Avalona Company, 875 Longwood Ave., Bronx, NY 10459.*

For sale: Sams 900-2004 plus four cabinets; also Sanyo, RCA and other various dealer manuals. Must sell; \$1350 or best offer. *Vernon Landis, 1315 Park Ave., Plainfield, NJ 07060; 201-753-6836.*

For sale: B&K 1077B TV analyst with leads and manuals, \$225 plus shipping. *Wizard Electronics, Route 5, Box 522, Renick, WV 24966; 304-497-2066.*

For sale: RCA TV model T100, chassis KCS38; not in working condition. Please state price. *George Saylor, 2319 Parrish St., Philadelphia, PA 19130.*

For sale: Heathkit FET/transistor and diode checker, \$45 plus shipping; Kirby flyback transformer checker, \$10 plus shipping; Supreme tube tester and VOM, needs minor repair, \$10. *John Brouzakis, Route 3, Box 602B, Charleroi, PA 15022; 412-483-3072.*

For sale: Hickok LX304 DMM with leads and battery, \$50. Send cashiers check or money order. *J. R. Janeczko, 409 4th Ave., Haddon Heights, NJ 08035.*

For sale: B&K 415 sweep/marker generator with all cables and operating manual, never used, \$150. Also Sams CB160-226, \$1 each, and kit of original Quasar modules, \$50. *Peter Daley, Daley's TV & Communications, 305 North St., Route 2, Box 34, Preston, MN 55965.*

For sale: Commodore 64 computer, \$275; satellite antenna low-noise amplifier, 120° LNA, \$295; Satec receiver, \$395. *Dennis R. Hallingstad, 608-269-2392, Sparta, WI.*

For sale: TV test equipment, Sams, tubes, etc. Send large SASE for list (two stamps). *Maurer TV Sales & Service, 20 S. 4th St., Lebanon, PA 17042.*

For sale: Sencore SC-60A scope, \$1200; Sencore VA-48 analyzer, \$800; Heath IM-5238 ac voltmeter, \$50. *Don Hicks, 3351 Madison St., Apt. 6, San Diego, CA 92116; 619-288-9416.*

For sale: Heath model IP2717A regulated high-voltage power supply, assembled and tested, \$160 including UPS. *Thurston Electronic Service, 5738 U.S. 33, N., Fort Wayne, IN 46818.*

For sale: Knight tube tester model KG600B, \$75; Heathkit, Simpson and Eico VTVMs, \$35 each; Heathkit by Daystron 5in scope, model 10-10, \$200. *E. Barlow, Box 29, Tweed, Ontario, Canada K0K 3J0.*

For sale: Simpson 467 digital voltmeter, \$200. *Ed Szymanski, 15 Chapman St., Bloomfield, NJ 07003.*

For sale: Approximately 500 new Astatic phonograph needles in three display cases. Numbers range from N2sd to N950. Will sell one or all at 80% discount. Display case free with purchase of 150 needles. *James R. Ince, Rt. 2, Box 67, Milton-Freewater, OR 97362.*

For sale: Sencore CG 138 color bar generator; Sylvania 19 in. test jig and adaptors; Eico tube tester model 667; best offer. Send SASE for list of service literature. *Lewis Radio & TV, Rontel, Central City, NE 68826.*

For sale: Conar model 251 oscilloscope, \$90; Conar model 682 TV pattern generator, \$60; Triad Utrad 500VA isolation transformer, used less than one hour, \$65. All plus postage. *Walter Fiscus Jr., Route 1, Box 345, Oxford, NC 27565; 1-919-693-1066.*

For sale: TV and VCR test equipment and service data. Includes Sencore SC-60A scope and VA-48 analyzer, counter, DVM and more. *Don's Video Service, 11381 Bootes St., San Diego, CA 92116; 1-619-578-8406.*

For sale: B&K model 470 picture tube rejuvenator with adaptors, \$240; B&K model 667 tube tester, \$200; Elenco model SG200 convergence generator, \$45. *J. Malone, 1-314-893-5069 (Jefferson City, MO)*

For sale: Sencore SC60 scope, complete with probes and instructions, \$1150. *Val Obal, 3201 S. 73 St., Omaha, NE 68124; 1-402-393-0459.*

Readers' Exchange listings are free and are limited to three items per month. "For sale" items must be used equipment sold by individuals, not companies. Send information to: Reader's Exchange, Electronic Servicing & Technology, P.O. Box 12901, Overland Park, KS 66212.



Circle (21) on Reply Card

Symcures Wanted

Electronic Servicing and Technology needs a broader variety of television Symcures. Especially needed are reports of Quasar, General Electric, Sylvania (or Philco), Sony Sears and Magnavox.

Symcures are, by definition, solutions to problems that have been encountered during the repair of *more than one* television set of the same make and model, and that may reasonably be expected to be a source of *recurrent* failure.

Please give the brand, model number, Photofact number, a brief description of the symptoms, a rough hand-drawn schematic of the area containing the defect, and a short description of the cure (including whether the defective component was open, leaky, shorted or intermittent).

ES&T editors will adapt the material to the Symcure format and have Photofact-style schematics prepared.

Send seven Symcures each time. Only six will be published, but the extra gives the editor a spare for one already printed in the past (or otherwise not suitable to the format). \$30 will be paid for each page of six actually published (remember to include full name and address).

Send to: Symcure Department
Electronic Servicing and Technology
P.O. Box 12901
Overland Park, Kansas 66212

Step-by-step earth station installation

By Tom Moore

Satellite receiving systems, or earth stations, are appearing in many out-of-the-way spots, from villages in India to rural farms in Iowa. But according to Allen Cook, a pioneer in installing these systems in the Kansas City, MO, area, the urban dweller also is installing these devices. He says that this is because they are tired of monthly bills from a cable company that can increase rates, poor service provided by some cable companies when there are outages and redundancy of programming.

Despite economic conditions, manufacturers are projecting a growth in sales that will reach 250,000 units in 1983. With this type of growth, it is important for members of the electronic servicing community to learn more about this new development.

The most important aspect of this new business is the proper installation of the receiving antenna. The three commonly used methods are surrounding the mount with concrete, surrounding it with foam and attaching the mount to a concrete pad.

No matter what installation method is used, the first step is proper site selection. Some companies, such as Discom, believe in hauling an actual receiving dish on a flat-bed trailer to the proposed site. With a TV monitor, Discom can check for any natural obstruc-

tions and see if any microwave transmissions are interfering with the reception. If microwave is detected, filters are introduced to see if the interference can be eliminated.

After Discom selects the proper site, employees dig a 3ft x 3ft hole and pour concrete around the mounting pipe. The engineers claim a 18in hole is all they need but they make it a yard for added safety.



The hole for the pad was slightly deeper than 3ft at the deepest point. Note the terracing of the hole.

Some installers use foam instead of concrete. This method is the result of installation practices of the telephone company when workers install a new telephone pole. They dig a 1ft x 4ft hole and insert a 6in water pipe and pack expanding foam around it.

The foam method is one of the two methods Rent-A-Vision uses.

While most companies sell a permanent installation, Rent-A-Vision has the unusual problem of having the customer return the merchandise and not continue with the lease. Therefore Rent-A-Vision demands a non-returnable \$500 installation fee.

The foam method is good if the customer might not keep the dish or might want to move it to another location someday. If it appears the installation will be permanent, Rent-A-Vision prefers a concrete pad.

There is some controversy between installers who use the quick methods of installation and the ones who believe the only proper installation is a solid concrete pad. While the Rent-A-Vision installer defends the foam method, he admits he prefers the pad method.

Hawkeye, located in Stanley, KS, has good reason for distrusting the quick methods for the 10ft dish. The company had several dishes set up in concrete. A heavy wind blew over all the 10ft dishes but left the 8ft ones still standing. This is because an 85mph wind will generate 6600 pounds of pressure against an 8ft dish, but an additional 2ft of dish causes the pressure to increase to 12,000 pounds.

A dish doesn't have to blow over to cause a problem. If a dish shifts its position just a foot, it will lose



The concrete is poured, leveled and allowed to set for at least two days.

its line of sight, resulting in a service call to correct this serious situation.

Hawkeye has devised its own method of a quick installation. It makes the concrete pads with the mount already embedded at the plant, then hauls the assembled installation to the site. Only three bolts must be adjusted to level the dish, and the owner can be taught to do this.

Allen Cook doesn't believe in any quick and simple method. He and his chief engineer, Frank Mathews, have spent several years installing earth stations. They have learned the hard way that the best method is a careful, step-by-step procedure, which takes several days to complete. Their method may be the least profitable initially, but they save money by not having to go back and correct a situation covered under warranty. Once they install an earth station, the dish isn't likely to shift or blow over.

I decided to record the steps Cook and Mathews use on an actual installation. The customer was a typical example of the type of person who is buying earth stations. He is a successful owner of a chain of pizza restaurants in the Kansas City area who owns a large, expensive house near Parkville, MO, and thinks it will be at least two years before he can get cable service where he lives. He is frustrated because he is missing out on various offerings by the local cable company, and he has poor reception of existing over-

the-air broadcasts because of his location.

The first step is site selection. The essential pieces of equipment used in this phase are a magnetic compass and an inclinometer. The compass is placed on the ground for precise azimuth bearings. At this particular geographic location, the receiving dish has to face magnetic south. The next step is sighting through the inclinometer from the prospective site at a 45° angle, looking for obstructions.

Any tree or building can become a major obstruction problem. One suggested site had a tree too close, and the owner did not want it removed, so Matthews went with a different site.

The next step is examining for possible exterior cable run. After that, Cook locates the three sets the owner wants hooked up. The family room set presents no problem because the existing antenna wire run path can be used, but figuring out how to hook up the other two sets requires information from the owner about attics and other structural details.

After these decisions have been made, it is time to build the foundation for the dish. Cook and Matthews think the best foundation is a 4ft x 4ft concrete pad anchored in the ground for at least 3 to 4ft. A high water table in the ground will freeze and expand, pushing a shallow pad out of the ground and causing a loss of line of sight.

After digging a hole for the pad, reinforcement rods are inserted. Matthews says this is important for keeping the concrete from cracking, which causes the antenna to shift. Finally, they pour the concrete and allow it to set for at least two days.

When the concrete has settled and hardened, it is time for the actual installation. Matthews uses a 7in pipe fastened to a 3-corner pedestal.

The team drills three holes into the concrete and inserts bolts. Before the pipe is bolted securely to the pad, the team uses a level to make sure the pipe is perfectly ver-

tical. After minor adjustments have been made by inserting thin washers under corners that are lower than the other two, the team has securely bolted the mount to the pad.

After the two sections of the dish are bolted together, a heavy mounting frame is attached to the back to give the dish a solid support.

The final phase is aligning the dish. Before attaching the feedhorn, the incline angle and line of sight are roughly aligned with a compass and inclinometer.

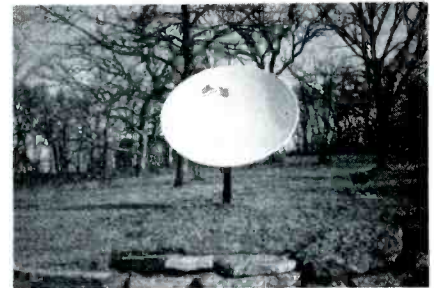

The installation for this small dish did not require a pad. The crew dug a hole and poured concrete around the pipe.

After the feedhorn is attached, it is time for the arcing procedure. This requires two people—one to make adjustments to the antenna and one to note the results. A good, rugged color TV set and a satellite receiver with a signal strength meter on the face are required.

First the dish is cranked around until good reception from one of the satellites shows up on the TV set. Next, one person adjusts the incline angle while the person watching the set notes a peak value on the meter. When the peak is found, they permanently set the incline angle. If it is done correctly, every signal from that satellite, as well as from other satellites, should come in perfectly.

The important point about any installation is that if it is done correctly, there shouldn't be any followup calls from an irate customer.

ES&T

MEDIA BUYERS:

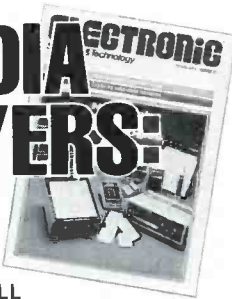

These firms ARE the electronics industry. And, they ALL advertise with ES&T...

AP Products
 B&K Precision
 Cleveland Institute
 Cooper Group
 John Fluke
 General Electric
 Global Specialties
 Gould Instruments
 Heathkit
 Hitachi
 Keithley Instruments
 Leader Instruments
 NRI Schools (McGraw-Hill)
 Panasonic
 Philips ECG
 RCA
 Howard W. Sams
 Sencore
 Simpson Electric
 Sony
 Sprague Products
 A.W. Sperry Instruments
 TCG/New-Tone
 Tektronix
 Ungar
 Winegard
 Zenith

...to name a few.

Your test equipment, replacement parts, books, schools, microcomputers, satellite TVRO, audio & video, and other servicing-related clients deserve ES&T, too.

It's the **HOT** new medium in electronics...

*More sales leads (over 100,000 in 1982)

*Total ad linage up by 300%

*Total ABC audited, paid-circulation has **doubled**

Go with those who know...

Ask for a media kit

ELECTRONIC

Servicing & Technology

Intertec Publishing Corporation P.O. Box 12901
 Overland Park, KS 66212 913/888-4664

Also publishers of

BROADCAST
 engineering

广播工程

VIDEO

Radio y
 Televisión



Test your electronic knowledge

By Sam Wilson, ISCET test director

These questions are similar to questions used on the various CET tests. All questions on the actual CET test are multiple choice, and a grade of 75% or better is required for passing. These questions are related to the Associate-level test section of questions that require mathematics. The answers are given on page-60. 58

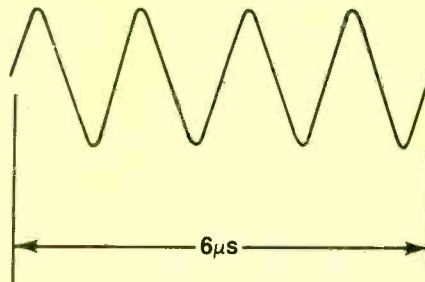

- The frequency of the voltage having the oscilloscope display in Figure 1 is
 - 66.67Hz.
 - 6666.67Hz
 - 66,666.67Hz.
 - 666,666.67Hz.
 - 6,666,666.67Hz.

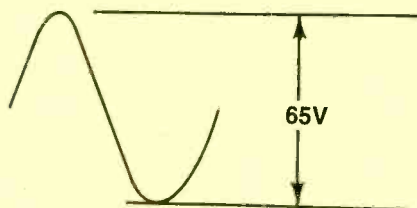

- What is the RMS value of the voltage waveform in Figure 2?
 - 45.96V
 - 41.38V
 - 22.98V
 - 20.7V
 - 15.9V

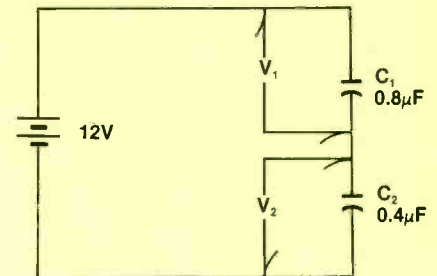

- What is the voltage across C_2 in the circuit of Figure 3? (Assume the capacitors are fully charged.)
 - $V_2 = 6V$
 - $V_2 = 4V$
 - $V_2 = 8V$
 - $V_2 = 7.33V$
 - None of these answers is correct.

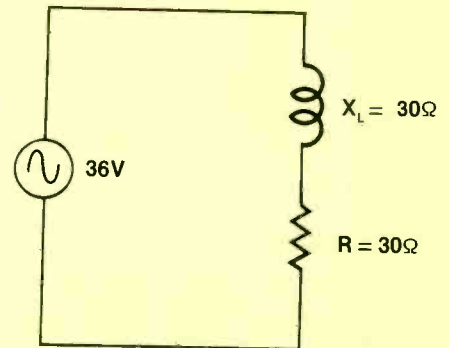

- What is the voltage drop across R in the circuit of Figure 4?
 - 36V

- B. 18V
- C. 12.6V
- D. 6V
- E. 25.4458V

5. A resistor having a color code of brown black black is connected directly across a 10V battery. How much current flows through the resistor?

- A. 1A
- B. 0.1A
- C. 10A
- D. 0.01A
- E. None of these answers is correct.

6. Which of the following is larger?

- A. 10,000pF
- B. 0.005μF

7. Which of the following equations is *not* correct?

A. $C = \frac{1}{2\pi f X_C}$

B. $X_L = 2\pi f L$

C. $Z^2 = R^2 + X_L^2$

D. $f_r = \frac{1}{2\pi\sqrt{X_L X_C}}$

E. $V = IR$

8. A resistor has a tolerance of ±5° when its fourth band is colored

- A. gold.
- B. silver.

9. If a 47K resistor has a tolerance of ±5%, what is the lowest value of resistance it can have and still be in tolerance?

- A. 44.3K
- B. 44.65K
- C. 43.35K
- D. 42.17K
- E. 42.71K

10. Two resistors are connected in a parallel circuit. The power dissipated by resistor x is 3W, and the power dissipated by resistor y is 6W. The power dissipated by the parallel circuit is

- A. 3W
- B. 2W
- C. 9W
- D. 6W
- E. 5.772W



Krista instruments



31B-430

6.5 MHz OSCILLOSCOPE

Sugg. List **\$209.95**

- Sensitivity - 0mV/Div.
- Input Imped. - Min. 35pF shunted
- Maximum vertical input voltage - 600V p-p or 300V (DC + AC peak)
- Attenuation 1", 1/10, 1/100
- CRT 75mm round screen
- 8-1/16" W x 8-7/16" H x 12 1/4" D
- Weight: 8.3 lbs.



30B-140

3 1/2 Digit LCD MULTIMETER

Sugg. List **\$49.95**

- AC DC to 1000V DC to 10A
- Resistance up to 2M ohms
- DC accuracy ±0.5% typical
- Auto polarity
- Low battery indicator
- Full overload protection
- 7" H x 3 1/4" W x 1 1/4" D. Wt. 16 oz.



503-180

Temperature Control Soldering Station

Sugg. List **\$69.95**

- Continuous temp. adjust. at front
- Temp. range 100°C to 500°C
- Heater power - 48W, 24W
- No RF interference
- LED indicators for power & heater
- Direct temp. indicating meter
- 4" W x 5" D x 3" H. Wt. 4 lbs.

1 Year Warranty
Parts & Labor

Call us for your nearest Distributor

Krista radio

P.O. Box 3424, Torrance, CA 90510
Tel: 213/328-9837 Telex: 182-392

DISTRIBUTOR & REP. INQUIRIES: Please use your company letterhead to request further details and our catalog.

Circle (23) on Reply Card

BELT IT TO 'EM

SELL BELTS AT A PROFIT USING THE PRB SYSTEM

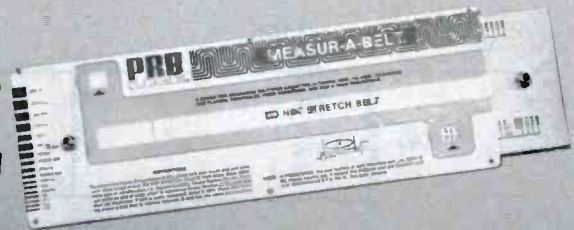

IT'S EXCLUSIVE!

Only PRB's copyrighted system puts the profit back into sell of projector and recorder belts. Because the PRB stock number actually describes the belt you want. Measure a belt and find it instantly, without time-consuming references and cross-references.

FREE WITH A \$50 ORDER

You can get a wealth of valuable information — not just for belts, but for other components, too — free from PRB. Ask how you can get the PRB Technician's Reference Library.

For profitable products — order the references you need to make them even more profitable — call PRB. 1-800-558-9572

In Wisconsin: 1-800-242-9553

Business Number: 1-414-473-2151

TLK: 4994411 PRB USA

In Canada call collect: 1-513-225-5003

PROJECTOR RECORDER BELT
200 Clay Street
Whitewater WI 53190



Circle (24) on Reply Card

Build your own logic probe

By Joe Sloop

A logic probe is a simple, inexpensive and valuable tool for troubleshooting logic circuit problems. The June 1983 issue of *ES&T* featured the article "Troubleshooting logic circuits logically," which describes what a logic probe is, how it works and how it is used. This article tells you how to build your own logic probe. Included are specifications, circuit description and instructions on

how to construct, test and use your probe.

Circuit description

The probe consists of two basic subsections. A voltage divider/comparator section senses and indicates by means of LED 1 or LED 2 whether the point being probed is at a logic low or high. A monostable multivibrator IC with its attendant circuitry provides a

means to indicate the occurrence of pulses via LED 3. Switch S1 will cause LED 3 to stay on indefinitely after the occurrence of a pulse.

Resistors R1, R2, R5/R6 and R7 provide voltage division between Vcc and ground. D1 protects the probe circuitry from damage should it be connected to an incorrect source polarity. The LM339 comparators are used to compare the voltage at the probe tip with 30% and 70% levels of the supply voltage. As the respective comparators turn on (go low) their LEDs conduct and glow, and an indication is provided of probe tip logic state.

A voltage divider/comparator input produces what is sometimes referred to as a *window comparator* because it allows only a portion (called a *window*) of the total applied voltage to trigger the comparator circuit. This type of circuit is used in systems that are CMOS compatible. You may upgrade this probe to be CMOS compatible by using another circuit (one capable of operating at CMOS supply voltages) for the pulse/memory IC, the 74121.

Setting the input *high* and *low* threshold voltages to 70% and 30%

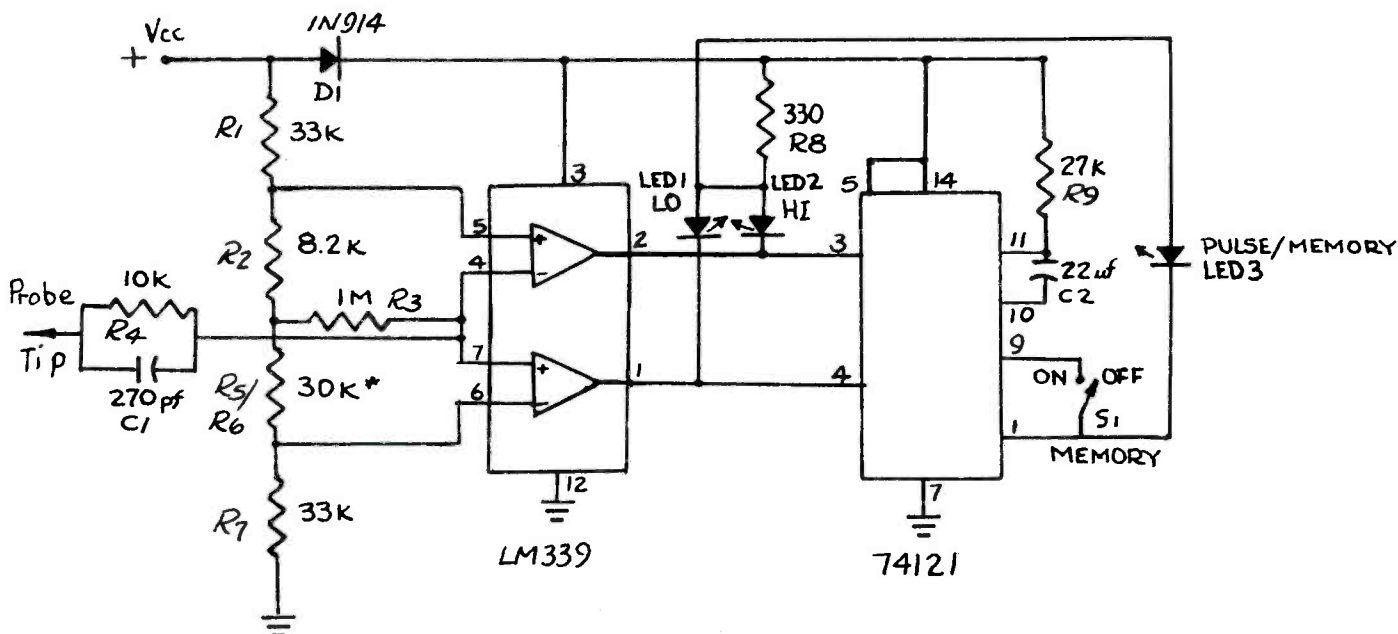

* R5/R6 MAY BE REPLACED BY TWO 15K RESISTORS

Figure 1. Schematic of logic probe.

of the TTL supply voltage, respectively, could cause the probe to indicate a TTL *low*, even if the voltage at the probe tip is as high as 1.5V, rather than the legal 0.8V. Also, the TTL *high* will be indicated if the voltage at the probe tip is as high as 3.5V, rather than the legal limit of 2.4V. It is conceivable that this could cause a problem, but the majority of problems will not be with "illegal" states or with marginal voltage levels. Because this probe does provide an indication of an illegal state (both LEDs *off* for voltages between 1.5V and 3.5V), it is easy to test the voltage with a voltmeter should this condition occur or if a questionable condition appears.

The 74121 is a monostable multivibrator triggerable by low-going inputs on both pins 3 and 4. When either of these pins goes low, the 74121 changes output states. Pin 1 is its Q output, which goes low as the circuit changes logic states. Capacitor C2 and resistor R9 form a pulse stretcher network, which keeps the monostable multivibrator in its unstable state for approximately 200ms.

Switch S1 is the memory switch. When it is closed, pin 1 is connected directly to pin 9. Upon arrival of any pulse at the probe tip, pin 1

will go low, taking the charge source from C2. Without a charge source, C2 cannot charge, and the multivibrator cannot time out (it remains in the triggered state and the pulse LED remains on until the memory switch is turned off).

Construction

Figure 2 shows the PCB layout. It is the correct size for direct use, so you may use it for photographically producing the PCB or as a guide to draw your pattern onto the copper-clad board via resist ink or pen. If you do not want to go the route of the PCB, the unit can be hard-wired using perforated plastic wiring board. In fact it can be made smaller by use of hard-wiring.

The probe tip may be made of 12 or 14 gauge copper wire or discarded test probe tips, or you can buy one.

Construction precautions

- Use the correct size drill bit.
- Use good soldering techniques (a low wattage iron, proper heat-sinking techniques and low-heat solder).
- Make sure ICs, diodes, C2 and LEDs are inserted correctly.

A variety of case styles is possible. Plastic tubing is available from hobby stores, and toothbrush box-

Specifications

Input impedance: 300k Ω
 Minimum input pulse width: 300ns
 Maximum input frequency: 1.5MHz (approximate). If higher frequency operation is required, use equivalent ICs with higher frequency response. These components are used because of exceptionally low cost. Also, as shown in Figure 1, the probe is usable in most typical TTL circuits.
 Logic thresholds:
 logic *high* - 70% of supply voltage

logic *low* - 30% of supply voltage
 Maximum supply voltage: 5Vdc ± 0.5 for TTL only. Input polarity protected
 Current requirements: 30mA at 5Vdc
 Maximum tip voltage: line voltage for 10s
 Pulse detector: 200ms pulse stretcher activated on input of any positive or negative-going pulse greater than 300ns.
 Memory (activated by *memory* switch): Memory LED lights with input of positive or negative-going pulse.

Isolate Regulate Evaluate

New B&K-PRECISION isolated-variable AC power supplies do it all!

These new AC supplies are designed to handle a wide range of engineering and service applications. With either supply you can:

ISOLATE products under test from the power line. A *must* for safe testing of transformerless (hot chassis) equipment.

REGULATE the voltage applied to the unit under test from 0-150 VAC. Perfect for stimulating "brown-outs" or over-voltage conditions. Also essential for supplying accurate input voltage to equipment being performance tested.

EVALUATE how equipment will perform under varying input voltages. The 1655 also lets you measure power line leakage.

Model 1655 \$350.00



- Handles 3 amps continuous; 4 amps intermittent
- Built-in leakage tester for OSHA, UL, CSA tests
- Soldering iron temperature control
- Dual isolated outputs

Model 1653 \$165



- Handles 2 amps continuous
- Large calibrated dual-scale meter
- Sturdy construction
- Compact size

The 1655 and 1653 are available for immediate delivery at your local B&K-PRECISION distributor. For additional information or the name of your local distributor call

1-800-621-4627.

B&K PRECISION

DYNASCAN CORPORATION

6460 West Cortland Street
 Chicago, Illinois 60635 • 312/889-9087
 International Sales: 6460 W. Cortland St., Chicago, IL 60635
 Canadian Sales: Atlas Electronics, Ontario
 South and Central American Sales:
 Empire Exporters, Plainview, NY 11803

Circle (27) on Reply Card

Books

Editor's note: Periodically *Electronic Servicing & Technology* features books dealing with subjects of interest to our readers. Please direct inquiries and orders to the publisher at the address given for each book, rather than to us.

The Apple II Circuit Description, by Winston Gayler; Howard W. Sams & Company; 240 pages; \$22.95.

The technical information in this book involves a detailed description of the Revision 1 Apple II motherboard, including the keyboard and power supply, and compares Revision 1 with other revisions. The schematics and waveforms make servicing and repair possible for technicians, hobbyists and engineers.

The chapters cover the clock generator, horizontal timing, video timing, the memory system, the 6502 and system bus, on-board I/O, the video display and video techniques. Each chapter contains a basic overview and detailed circuit analysis for more experienced or adventurous readers.

Published by Howard W. Sams & Company, 4300 W. 62nd St., Indianapolis, IN 46268.

The Complete Book of Oscilloscopes, by Stan Prentiss; Tab Books; 188 pages; \$17.95 hardbound, \$10.95 paperback.

Anyone interested in oscilloscopes or CRT-readout measuring instruments can find practical information in this book. The practicing engineer, technician or hobbyist can gain new insights into using equipment already on hand and learn how to use the newest instruments. Those just getting started will have an opportunity to build a thorough understanding of the basics and be able to advance to more sophisticated applications.

The author covers service and laboratory scopes, low- and high-frequency spectrum analyzers, sampling and storage scopes,

NTSC and sidelock vectorscopes with waveform generators, logic and signature analyzers, time-domain reflectometry instruments and a combination waveform and spectrum analyzer.

Published by Tab Books, Blue Ridge Summit, PA 17214.

Television Electronics Theory and Service, by Milton Kiver and Milton Kaufman; Van Nostrand Reinhold; 963 pages.

This reference volume gives a background of all aspects of TV operation and also covers state-of-the-art TV applications. Both solid-state color and black-and-white receivers are covered as the authors examine each section separately.

Topics include tuners, video IF amplifiers, vertical deflection circuits, automatic gain control, sound circuit, video detector, horizontal AFC, vertical oscillators, horizontal oscillators, horizontal deflection circuits, high-voltage circuits, synchronizing circuits and more.

Published by Van Nostrand Reinhold, 135 W. 50th St., New York, NY 10020.

Active Filter Design, by Carson Chen; Hayden Book Company; 133 pages; \$10.95.

This comprehensive text provides students and engineers with a clear understanding of the hows and whys of active filter design.

The book is directed to those not familiar with the subject of active filters, and begins by explaining the advantages and disadvantages of passive, active and digital filters. It covers filtering terminology and presents a quantitative discussion of decibels, the Quality factor, transfer functions and the damping factor.

The book continues with a section on a transfer function's poles, zeros, magnitude, phase and Bode plot. It then develops the transfer functions of five basic filters: the lowpass, highpass, bandpass, bandreject and allpass filters.

The final two chapters deal with the theoretical aspects of filtering approximations and the area of cascading, normalization, frequency transformation and impedance scaling.

Published by Hayden Book Company, 50 Essex St., Rochelle Park, NJ 07662.

ES&T

PREVENT HI-TECH HEADACHES

Our Isolators eliminate equipment interaction,

clean up interference, curb damaging power line spikes and lightning bursts.



ISO-1 Isolator

3 isolated sockets; quality spike suppression; basic protection. . . \$76.95

ISO-3 Super-Isolator

3 dual isolated sockets; suppressor; commercial protection. 115.95

ISO-17 Magnum Isolator

4 quad isolated sockets; suppressor; laboratory grade protection. . . 200.95

ESP Electronic Specialists, Inc.
171 S. Main St., Box 389, Natick, MA 01780

Toll Free Order Desk 1-800-225-4876
MasterCard, VISA, American Express

Circle (28) on Reply Card

UNIVERSAL CRT ADAPTER

- Works with **All** color CRT testers
 - Checks virtually **Every** color CRT
 - Money-back guarantee
 - Test/Restore/Rejuvenate
 - Distributors inquiries welcome
 - \$59.95 & \$2.00 shipping & handling
- Master Card/Visa Accepted

CA28 3 Piece Adapter Kit

Set-up manual included

Dandy Manufacturing Co.

1313 N Main St,
Muskogee, OK 74401
918 682-4286

Call Toll Free
1-800-331-9658

Circle (29) on Reply Card

Part 2

Servicing

the RCA CTC 108

unitized chassis

By Stan Vittetoe, CET

Servicing the regulator

When the SCR-regulator function is suspected of producing excessive voltage and causing start-up immediately followed by shut-down, or when suspected of producing zero or low output voltage, the first step should be a few quick resistance tests around the SCR. Check the resistance across C106. This will show a shorted SCR or C106, because they are in parallel (except for R127 and the flyback winding). A high reading proves there is no serious short circuit, while a low reading indicates separate tests are needed for the SCR and C106.

Secondly, measure the dc voltages at C106. A lack of +167V at the positive terminal proves the line-rectified primary dc supply has a defect, while a normal reading at the C106 positive terminal frees the +167V supply from suspicion. The dc-voltage reading at the negative C106 terminal (or the SCR cathode) is very important. A low reading combined with no sound and picture usually points toward a dead horizontal-sweep function. A zero voltage (after +167V was found at the SCR anode) might be caused by a shorted zener CR105 that regulates the +33.5V for the regulator circuit. The same high reading at both ends of C106 indicates it is shorted or the SCR is shorted.

A picture with horizontal tearing hints at a regulator circuit that is not synchronized to the horizontal frequency. Check the resistance of

R124, and scope the flyback end, expecting 200VPP of positive-going pulses. Replace an open or increased R124, or find the reason the pulses are missing.

If it is necessary to operate the receiver without the regulator, reduce the line voltage to about 70Vac, place one clip-lead short across C106 and another from cathode to gate of SCR101 *before* applying ac power. If the regulator circuit is at fault, this should produce a picture with sound. Otherwise, the shut-down circuit or the horizontal-sweep system might be at fault.

Testing the horizontal sweep

When the SCR-type regulator seems to be operating correctly but there is no raster or high voltage, use a scope to check important waveforms in the horizontal oscillator, driver and output stages.

If there are any signs of overload or overheating, disconnect the horizontal-output transistor collector by removing the one mounting screw that completes the circuit. (Removing both screws will disconnect Q412 collector, but the nut from the other screw often falls inside the chassis or cabinet and can be difficult to remove.)

With the horizontal-output transistor disabled, there are no sweep-rectified dc voltages present, so the horizontal-driver transistor (Q411) should be operating on about +50V from the start-up circuit through CR406. The collector waveform will have reduced

amplitude because of the lower voltage. For the same reason, the oscillator output should be about 5VPP, instead of the usual 20VPP. These start-up voltages will guide you in identifying defective components or the stages with defects.

In the Figure 3 oscillator circuit, C410 has opened intermittently in a number of CTC108 receivers, causing loss of picture and sound. If the horizontal oscillator is not working, but the start-up dc voltage is present, analyze the oscillator stage by testing the dc biases and other voltages at all transistors.

Fail-safe shut-down circuit

If the oscillator stage operates on the start-up dc voltage and nothing can be found wrong with the horizontal-sweep system, suspect the X-ray protection shut-down circuit. Of course, excessive CRT current, some flyback problems and excessive pulse amplitude from the flyback can activate the shut-down circuit without leaving any signs to follow, or the shut-down circuit can be defective. My method of identifying which situation is responsible is to measure the voltage drop across 1000Ω R433 (Figure 4). If the circuit is latched in the shut-down mode, about 1Vdc to 2Vdc will be across R433. During normal operation, the voltage drop is zero.

When these tests show shut down has occurred, you must determine whether the problem is overvoltage, overcurrent or a shut-down circuit defect. If ex-

cessive CRT current is the problem, shut off the ac power for several seconds to unlatch Q413 and Q414, ground the Q415 collector and turn on the ac power. The receiver should come alive if CET current or a Q415 circuit defect is the problem.

If the receiver is in shut down because of excessive high voltage (and flyback pulses), reduce the line voltage for safety reasons and short together the base and emitter of Q413. Restoration of the operation indicates excessive high voltage is the cause of shut down.

Zener CR407 has caused erratic shut down by reducing the Q413 base voltage and making the shut-down action too sensitive. Also, increased resistance of R727 will affect the operation exactly as though the high-voltage current is excessive. Test all these resistors.

Never return one of these receivers to a customer without testing the unit by shorting together the XT1 and XT2 test-points and activating normal shut down. If this shut down does not occur, repair the circuit so that it does.

Horizontal-output problems

Each CTC108 chassis includes an integrated high-voltage transformer (IHVT) that has the high-voltage rectifier diodes inside the doughnut insulation. The high-voltage pulses are produced and rectified inside the flyback and there is no high-voltage tripler.

A failure of either the internal diodes or the flyback winding requires replacement of the T402 flyback.

If your tests find a defective horizontal-output transistor, there is a strong possibility that a flyback defect has caused the transistor failure. Before applying ac power after the transistor replacement, however, disable SCR101 and jumper C106, and then apply about 60Vac to the receiver while you scope the waveform at the Q412 output-transistor collector. If it is a normal pulse waveform of about 500VPP, go ahead and slowly increase the line voltage to the normal 120Vac.

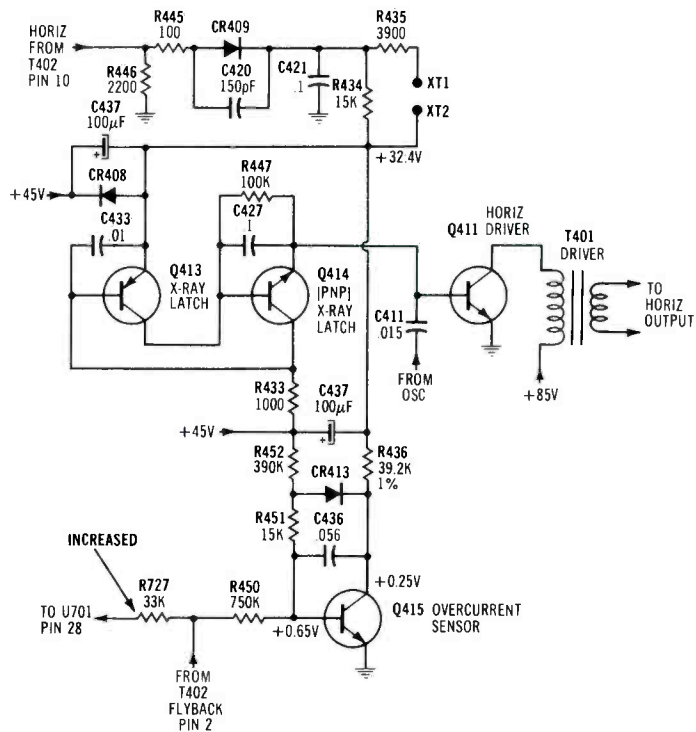

Figure 4. Q413 and Q414 form a locking switch. The collector of Q413 is connected directly to the Q414 base, and the Q414 collector is connected directly to the Q413 base. At rest, neither transistor has C/E current. Q413 is reverse biased, and Q414 has zero forward bias.

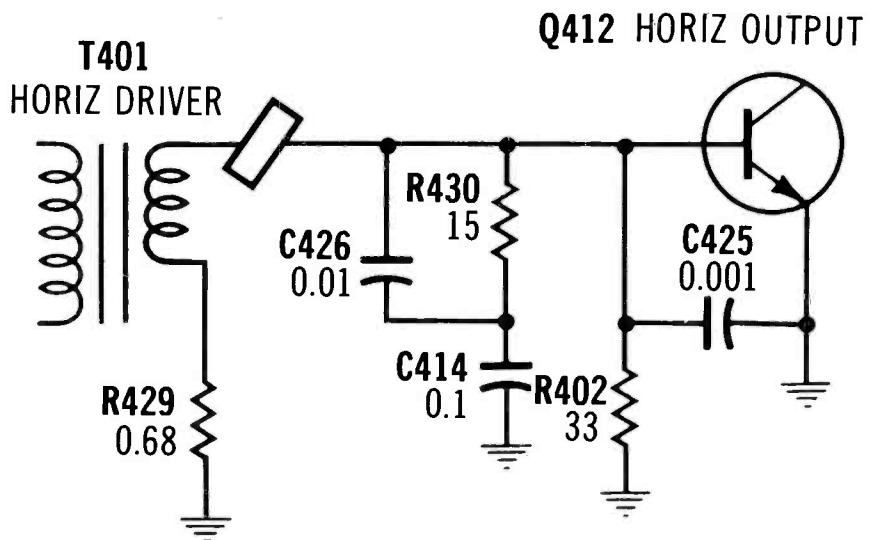

Figure 5. When you notice problems of erratic horizontal linearity or foldover, check the soldered joints at the T401 lugs and all resistors in the base circuit of Q412 horizontal-output transistor.

But if the collector waveform has ringing, some turns might be shorted in the high-voltage flyback winding. Other distortions of the collector waveform indicate a bad IHVT or a short in one of the sweep-rectified supplies. Of course, you should not ignore the possibility of a bad yoke or a problem in the centering circuit.

Other possible troubles include bad solder connections around the T401 driver transistor or resistors in the base circuit of Q412, the output transistor (Figure 5). Also, an open or increased value of R440 at the T403 pincushion transformer (Figure 6) can narrow the picture.

Vertical-sweep defects

Servicing the vertical-sweep system in the CTC108 is made easier by the 2-transistor oscillator circuit that does not need a positive-feedback signal from the output stage to produce oscillation. If both output transistors are open, for example, the oscillator continues to operate, producing a sawtooth-waveform drive signal at the height control (Figure 7).

A circuit that is difficult to understand, although not unusually hard to repair, is the output stage with two power transistors. During part of the vertical cycle, one output transistor acts as driver for the other. Later in the cycle, they exchange functions, with the other acting as driver. Fortunately, a technician can troubleshoot efficiently without a perfect understanding of the theory. Remember that normal output operation produces about half the supply voltage at the output signal from the Q506 emitter. This should be the first measurement.

If resistor R515 (4.7Ω) increases in value, the height will be reduced. Other resistors, particularly the R514 and R510 220KΩ resistors, can eliminate the vertical sweep if they develop appreciably higher resistances. Also, vertical hold controls (R4206) have been known to leak to their grounded cases, causing loss of oscillation.

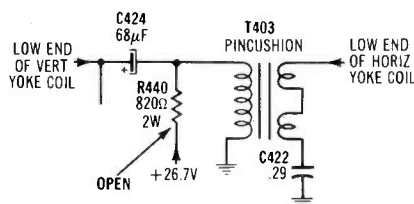

Figure 6. Narrow width in the CTC108 can be caused by increased resistance of R440 in the pincushion-elimination circuit.

Servicing the IF circuits

The SF301 SAW (surface acoustical wave) filter that replaces some IF tuned circuits cannot be adjusted. In the CTC108 chassis, suspected problems in SF301 or the Q301 IF stage can be tested by bypassing them (Figure 8). Unplug the IF cable from the circuit board and connect the center conductor directly to pin 16 of IF IC U301. This couples the tuner signal directly to the IF amplifier, so any strong signal should be seen (although smeared and degraded) on the picture tube.

RCA manuals suggest making this connection in series with a 1000pF capacitor, and this is valid if the chassis does not add dc AGC to the IF signal coming through the cable. However, when the AGC rides on the IF cable center conductor, as it does in the CTC108, such a coupling capacitor would block the AGC and ruin the test. Pin 16 has about 4Vdc, which is enough to operate the tuner AGC when it is coupled directly without the coupling capacitor. Therefore, choose whether to use the coupling capacitor or not according to the specific RCA receiver.

Use extreme caution when testing or connecting to U301 pin 16. If it is shorted to ground, even for a fraction of a second, the IC will be destroyed.

Complete loss of picture has been traced to an open coil (L309 at collector of Q301). Also, a snowy picture was caused by an IF cable that tested 12KΩ leakage, which reduced the tuner AGC voltage.

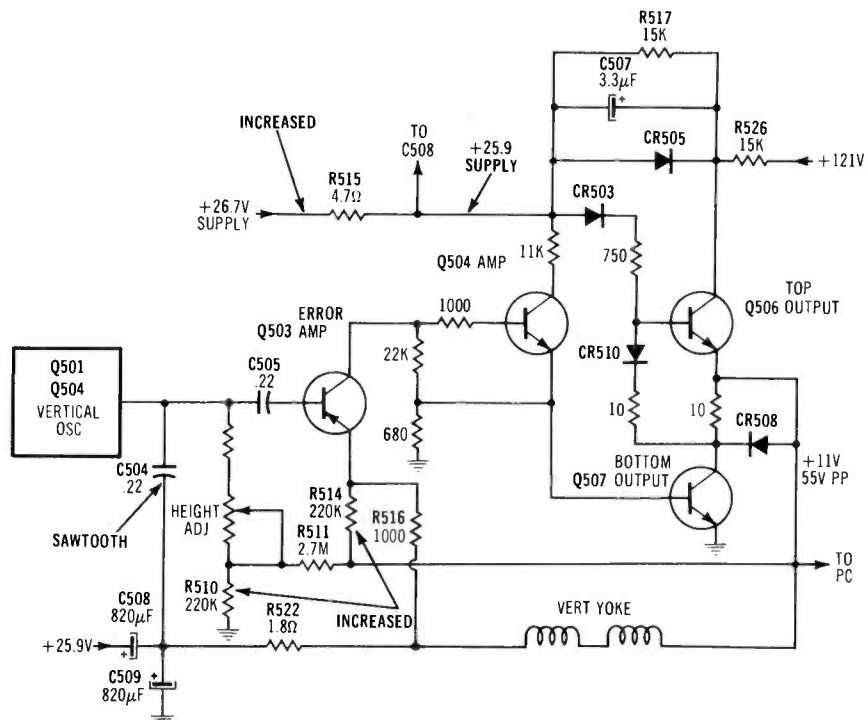

Figure 7. Arrows point to the most likely sources of reduced height or erratic vertical sweep. C508 and C509 are coupling capacitors for the vertical-yoke coils, so reduced capacitances in them can reduce the total height, spreading the linearity at the top of the picture and compressing the bottom. Notice that the yoke cold end returns to the C508 and C509 in addition to C504, the sawtooth-forming capacitor.

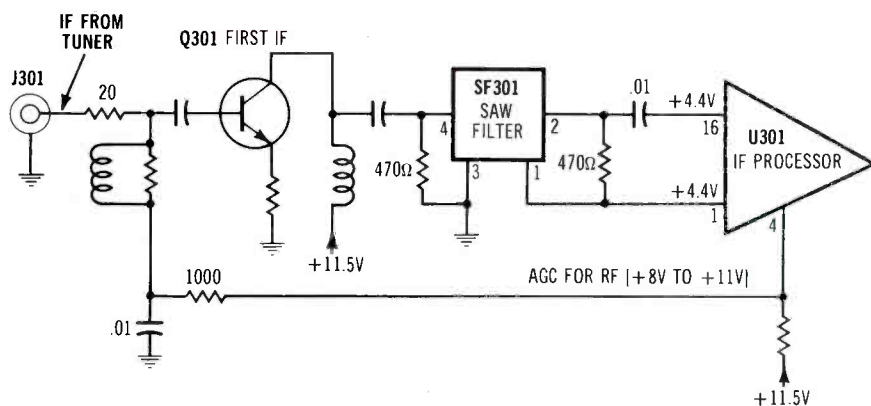

Figure 8. Some RCA unitized chassis, including the CTC108, apply the tuner AGC dc voltage to the center conductor of the tuner-to-chassis shielded cable.

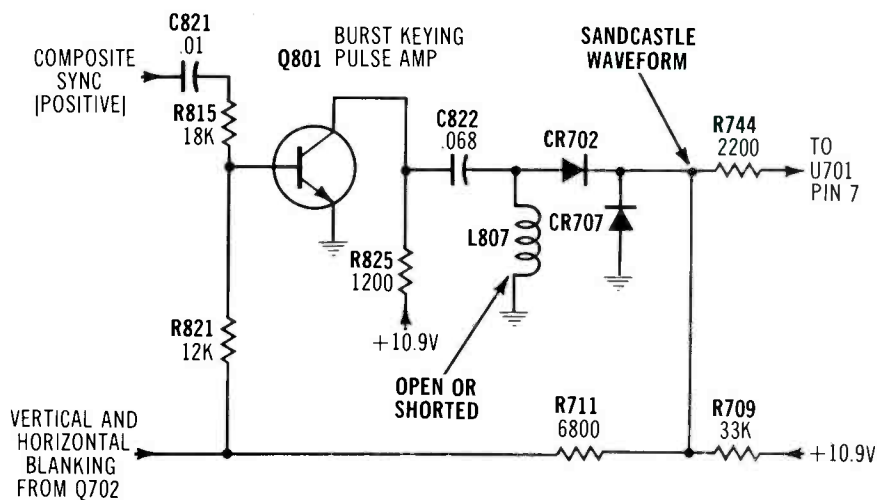

Figure 9. Vertical blanking, horizontal blanking and burst keying pulses are combined to make up the *sandcastle* waveform that is applied to U701 IC. C822 and L897 ring from each horizontal amplified and inverted horizontal sync pulse. The first positive peak of the ringing has the correct timing for use as burst keying.

Luminance and chrominance

Both luminance and chrominance signals are processed by IC U701. An unusual signal at pin 7 has been called the *sandcastle*, because of its resemblance to a sandcastle on the beach. The peculiar waveshape has no special significance, because it is made by combining vertical-blanking, horizontal-blanking and burst-keying pulses. The individual pulses are recovered inside the IC.

Remember, however, that absence of the sandcastle waveform will eliminate the luminance and color signals at the IC outputs.

Steady or intermittent loss of color can be caused by bad coils

around U701. Always check L807 (see Figure 9) because it can open or short, thus removing the burst-keying pulses. Weak color, no color or degraded color can be produced by a defective U701. Check for chroma at U701 pin 3 (TP801), and the 3.58MHz subcarrier at TP807 (pin 15).

If you replace IC U701, always readjust the AFPC color locking, because each IC is slightly different. Also, when the complaint is loss of color with weak signals, adjust the AFPC. It is possible to replace U701 because of no color and still have no color with the new one, if the AFPC needs adjusting.

To adjust the AFPC, ground

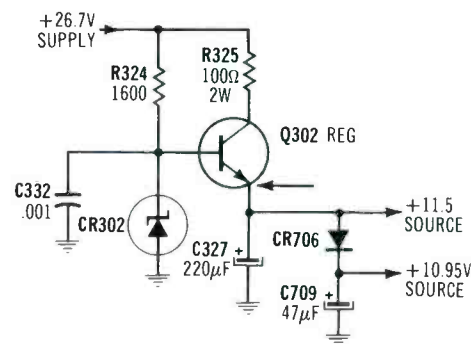

Two dc supply voltages come from the Q302 regulator. Check for a loose soldering joint at the Q302 emitter. It can cause intermittent video or color.

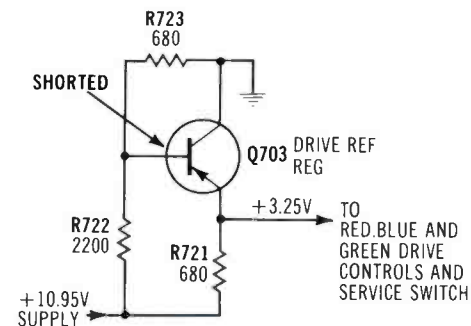

A short in Q703 drive-reference regulator can produce excessive brightness or a dark picture according to the elements shorted.

TP801, connect a 270pF capacitor between TP301 and U701 pin 1, and adjust color-oscillator C818 for a stable picture without sideward drift. That is all, except for removing the ground and the test capacitor. Incidentally, bad solder joints have been found at C818.

ES&T

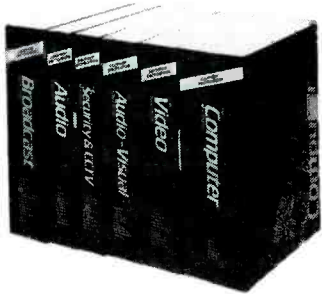

Professionals, Here are your Black Books

- Over 1500 Manufacturers
- 25,000 Products
- 8½" x 11" Catalog Format
- Perfect Binding for Durability
- Pictures, Descriptions, Features, Options, Specifications, Prices
- Up-to-date as of August 1983

Telephone Orders Accepted With
Purchase Order or Credit Card

Call Toll Free (800) 255-6038

HIGH TECH MARKETING CO.
P.O. Box 2056
Shawnee Mission, KS 66201

Exclusive Distributors for BILL DANIELS CO., INC.

Circle (30) on Reply Card

ESR METER

checks electrolytics
IN-CIRCUIT and is TV shop
FIELD-TESTED:

The most fantastic instrument I've ever bought—Billings, Mt. Used it 3 months; it only missed once—Marinette, Wis. (Typical). Squeal & no sync: 3 bad caps in B+ & AGC; Many Thanks—Taos, N.M. Please ship another; very satisfied—Glen Rock, Pa. It's fantastic—St. Joseph, Mo. Please rush; heard good reports—Hicksville, N.Y. One tremendous meter—Alexandria, Minn. Send your Super meter; heard about it—N. Olmstead, Ohio. Love that ESR Meter—Acton, Mass. Used it intensively for 30 days; it's been 100% effective—Pittsburgh, Pa.

Ideal for preventive maintenance: measures electrolyte dryness & shows up intermittent opens.

60-day Satisfaction Guarantee.

Send check or M.O. or call
(313) 435-8916 for COD

Or write for free brochure to:

Creative Electronics

ESR Brochure \$ 99.00
1417 N. Selfridge postpaid
Clawson, Mich. 48017 USA & CAN.

Circle (31) on Reply Card

Products

Drop-proof multimeters

A.W. Sperry Instruments has announced the introduction of their new line of drop-proof multimeters. The AWS "DP" series is made up of four pocket-size multimeters designed to withstand everyday rough usage.

Models DP-300, 306, 310 and 316 all feature shock-absorbing PCB



mounting, taut-band meter and low 25Ω and 30Ω mid-scales, and measure up to 1200Vac and dc.

Circle (75) on Reply Card

Shock sensor

A solid-state shock sensor that provides automatic reset plus a latching LED, is now available from *Sentrol*. The fully adjustable unit is not subject to vibration caused by passing trucks, wind gusts or even knocking on the window. This high degree of reliability is accomplished through use of a patented filtering method that discriminates against unwanted signals.

The *Sentrol* unit is available in models with 2-wire open loop, supervised 4-wire or automatic reset on loop relay. Both 6 and 12V styles are available with low current drain (less than 7mA) in the non-alarm mode.

Circle (77) on Reply Card

Answering machine protection

Electronic Specialists has introduced Kleen Line protection for phone answering machines that suppresses damaging telephone and power line spikes caused by lightning, spherics or phone office switch gear. The system uses modern semiconductor, gas

discharge tube and metal oxide varistor suppression techniques.

Circle (78) on Reply Card

Loop tester

The model 4 telephone tester from *Triplet* is custom designed for installation or repair service work on telephone company or



privately installed telephone systems.

It includes 8455 type tester capabilities, five new fixed tone frequencies (including 2713Hz as required by most recent Bell practices), plus two programmable frequencies, two additional ohm ranges of 10MΩ and 100MΩ, and additional 15Vdc range and quiet termination.

Circle (76) on Reply Card

Digital clamp meter

A new hand-held digital clamp meter from *Extech International* measures dc volts (200mV to 1000 full scale), ac volts (200 to



1000Vac; 40 to 500Hz), ac current (20A to 400A), resistance and diode check. Other features include a 3½-digit LCD display with auto zero, auto polarity and low battery. Because of an LSI circuit, measurements are possible even under strong magnetic field.

Circle (79) on Reply Card

Logic analyzer

OmniLogic has announced the latest addition to its line of logic analyzers: the OMNI II. It is designed to integrate the utility of a timing/state logic analyzer with a full-function CP/M microcomputer, all in a 27-pound package.

Upon power-up, the Omni II invokes an automatic self-check of its internal circuitry. The "set-up page" will then automatically appear, allowing configuration of the



Circle (81) on Reply Card

machine for data collection. The Omni II can collect 1000 data samples on each of 16 channels or up to 48 channels of 330 samples each.

Telephone wall jacks

Pfanstiehl has added two modular, flush wall jacks to its telephone line. The TL-WALLJJ is a duplex jack that covers the in-the-wall junction box. It can be used to hook up two telephones or one telephone and answering device or modem. The TL-RWALLJ, with round face plate, covers the in-the-wall junction box and is used to replace older, standard-type 4 hole, round face plates.

Circle (84) on Reply Card

Plug-in field-strength element

The latest addition to the plug-in elements for *Bird* directional wattmeters is a relative field-strength



element. Model 4030 expands the usefulness of the thousands of ThruLine wattmeters in the field by helping optimize the radiated signal of any transmitter from 2MHz to 1000MHz.

Circle (82) on Reply Card

Back-up power supply

PTI Industries has introduced a 200W back-up power supply designed to protect the personal computer user from altered and lost data due to power irregularities as well as complete loss of power.

The system comes complete with a battery and two ac outlets. Installation is accomplished by plugging the unit between the ac wall outlets and the equipment to be protected. In the event of a power loss, PTI's back-up power supply takes over and continues to supply 60Hz, 120V power to the user's equipment.

Circle (80) on Reply Card

Frequency counter

Global Specialties' new 1GHz frequency counter, model 6002, offers frequency measurement from 5Hz to 1GHz, and also measures period from 100ns to 200ms. This

It's no puzzle to order Oelrich Service Forms





For TV-radio and two-way radio service - legal forms for Calif., Florida and Utah. Now at parts jobbers or write for cat. 864.

OELRICH PUBLICATIONS





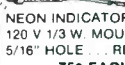

4040 N. Nashville Ave., Chicago, IL 60634
Now call toll-free! 800-621-0105

Circle (26) on Reply Card

TOLL FREE ORDERS • 1-800-826-5432
(IN CALIFORNIA: 1-800-258-6666)
AK, HI OR INFORMATION • (213) 380-8000

5 KEY ASSEMBLY  \$1.00 EACH CONTAINS 5 SINGLE-POLE NORMALLY OPEN SWITCHES. MEASURES 3 3/4" LONG	MINIATURE 6 VDC RELAY  SUPER SMALL SPDT RELAY. GOLD COBALT CONTACTS. RATED 1 AMP AT 30 VDC. HIGHLY SENSITIVE. TTL DIRECT DRIVE POSSIBLE. OPERATES FROM 4.3 TO 6 V. COIL RES. 220 OHM. 1 3/16" x 13/32" x 7/16" AROMAT # RSD-6V \$1.50 EACH 10 FOR \$13.50
6 KEY ASSEMBLY  \$1.25 EACH CONTAINS 6 SINGLE-POLE NORMALLY OPEN SWITCHES. MEASURES 4 1/4" LONG	13 VDC RELAY  CONTACT: S.P.N.C. 10 AMP @ 120 VAC ENERGIZE COIL TO OPEN CONTACT... COIL: 13 VDC 650 OHMS SPECIAL PRICE \$1.00 EACH
120V INDICATOR  NEON INDICATOR RATED 120 V 1/3 W. MOUNTS IN 5/16" HOLE... RED LENS. 75¢ EACH 10 FOR \$7.00 100 FOR \$65.00	FREE SEND FOR NEW LARGER 48 PAGE CATALOG

MINIATURE TOGGLE SWITCHES
ALL ARE RATED 5 AMPS @ 125 VAC

S.P.D.T. (on-on)  P.C. STYLE. NON-THREADED BUSHING 75¢ EACH 10 FOR \$7.00	S.P.D.T. (on-on)  SOLDER LUG TERMINALS \$1.00 EACH 10 FOR \$9.00 100 FOR \$80.00	S.P.D.T. (on-off-on)  SOLDER LUG TERMINALS \$1.00 EACH 10 FOR \$9.00 100 FOR \$80.00
S.P.D.T. (on-off-on)  NON-THREADED BUSHING 75¢ EACH 10 FOR \$7.00	S.P.D.T. (on-on)  P.C. LUGS. THREADED BUSHING \$1.00 EACH 10 FOR \$9.00 100 FOR \$80.00	D.P.D.T. (on-on)  SOLDER LUG TERMINALS \$2.00 EACH 10 FOR \$19.00 100 FOR \$180.00

ALL ELECTRONICS CORP.
ALL ELECTRONICS CORP.
905 S. VERMONT • P.O. BOX 20406 • LOS ANGELES, CA 90006

- QUANTITIES LIMITED
- MINIMUM ORDER \$10.00
- USA: \$2.50 SHIPPING
- NO C.O.D.!
- FOREIGN ORDERS INCLUDE SUFFICIENT SHIPPING
- CALIF. RES. ADD 6 1/2%

Circle (32) on Reply Card

CONSUMER PRODUCTS DISTRIBUTING COMPANY, INC.
3330 Pagosa Ct., Indpls., IN 46226

ONE OF THE LARGEST SONY PART DISTRIBUTORS

SUPER SPECIALS

10%-20% off all Color CRTs
ALL COLOR CRTs ARE INSTOCK

ICs and Transistors

	Reg.	Special
SG-613	16.20	13.00
2SC-867A	5.24	4.50
2SC-1114	9.11	7.50
2SA-1027R	2.69	2.00
MN-8303	5.24	4.50
2SC-1364	2.69	2.00

Many Others On Special

Video Heads
Motors
Transformers

EVERYTHING ON SALE

Over 9,000 Parts In Stock
NO MINIMUM ORDER AMOUNT
We Carry Only Genuine Sony Parts



In Indiana Call
1-317-897-4602
Out of Indiana
Toll Free
1-800-428-8353
OFFER EXPIRES
3-23-84

Circle (33) on Reply Card

Marketplace

1983 I.C. MASTER 2-VOLUME EDITION

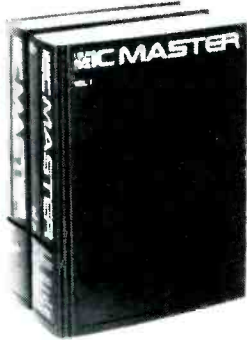

The only publication with the answers to your questions on integrated circuit and microcomputer board selection

55,000 entries in the world's most comprehensive function-for-function, pin-for-pin I.C. replacement guide.

3500 pages organized by function, type, and key parameters to make finding the device which best satisfies a need fast and easy.

For a FREE 6 page brochure about the I.C. Master, call, write or circle reply card.



P.O. Box 8000
Westboro, Mass. 01581

Toll Free: 1-800-343-0874
Mass. Call: (617) 366-0500

Circle (34) on Reply Card

FREE KIT Catalog

Test Equipment-Kit or Assembled
FUNCTION GENERATOR Kit \$59.95
Auto-Ranging Cap-meter kit \$79.95

Phone 209-772-2076

Circle number or phone for catalog.

contains
TEST &
EXPERI-
MENTER'S
EQUIP.

DAGE SCIENTIFIC INSTRUMENTS
BOX 144 VALLEY SPRINGS CA 95252

Circle (35) on Reply Card

SATELLITE TV VIEWERS

Get the most complete weekly listings.
Send \$1 for sample copy.



P.O. Box 308, Fortuna, California 95540
800-358-9997 (U.S.) • 800-556-8787 (Calif.)
707-785-2476 (all others)

Circle (36) on Reply Card

Use ES&T
classified ads



unit offers three selectable resolutions (cycles averaged in the period mode) with LED indicators and simple push-button control. A 10 MHz crystal oven oscillator time-base assures ± 0.5 ppm (10-40°C), ± 1 ppm/year stability.

Circle (83) on Reply Card

Word recognition probe

The Connecticut MicroComputer WRP-1 word recognition probe gives the LA-12 12-channel logic analyzer full word recognition capability. The WRP-1 allows the designer to start or stop the analyzer at a definite address or logic state in a program sequence. The data stored in the logic analyzer can then be viewed on the LA-12 to analyze the data relevant to that portion of the program sequence.

Circle (86) on Reply Card

Answers to quiz

(from page 47)

1. *D* It takes $6\mu\text{s}$ to complete four cycles, so, it takes $1.5\mu\text{s}$ to complete one cycle. In other words, the period (*T*) is $1.5\mu\text{s}$.

$$f = \frac{1}{T} = \frac{1}{1.5 \times 10^{-6}}$$

$$= 666,666.67\text{Hz}$$

Two important equations in electronics are:

$$T = \frac{1}{f} \text{ and } f = \frac{1}{T}$$

2. *C* Technicians sometimes get careless with this type of question. The peak-to-peak voltage is given, but the RMS value is based on the peak voltage.

$$V = 0.707 \times \frac{65}{2} = 22.98\text{V}$$

3. *C* The larger voltage is across the capacitor with the lower capacitance value. In this case, the voltage across C_2 must be twice V_1 :

$$V_2 = 2V_1$$

The sum of the voltages equals the supply voltage:

$$V_1 + V_2 = 12\text{V}$$

Substitute $2V_1$ for V_2

$$V_1 + 2V_1 = 12$$

$$3V_1 = 12$$

$$V_1 = 4\text{V}$$

$$V_2 = 2V_1 = 8\text{V}$$

4. *E* The voltages are in quadrature. They cannot be added like numbers in arithmetic. Think of the voltages as being two equal-length legs (*V*) of a right triangle that has a hypotenuse of 36. By the Pythagorean Theorem:

$$(V_L)^2 + (V_R)^2 = 36^2$$

$$2(V)^2 = 1296$$

$$V^2 = 648$$

$$V = \sqrt{648}$$

$$= 25.4458\text{V}$$

5. *A* The resistance value is 10 Ω

$$I = V/R = 10\text{V}/10\Omega$$

$$= 1\text{A}$$

6. *A* 10,000pF = 10nF
0.005 μF = 5nF

7. *D*

8. *A*

9. *B* $\pm 10.05 \times 47\text{K} =$
 $\pm 2.35\text{K } 47\text{K} - 2.35\text{K} =$
44.65K

10. *C* The power dissipated is always the sum regardless of whether the resistors are in series or parallel.

YOU CAN'T BEAT THE SYSTEM

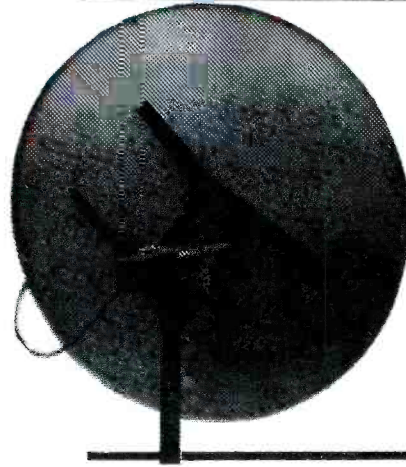

8' FIBERGLASS

- One piece construction
- Reflector weight 80 Lbs.
- Focal point of 27³/₄"
- F/D of .275
- Gain of 37.8 dB
- Noise at 50° elevation 30°K
- Mount complete with 3¹/₂" pole
- Polorotor I standard

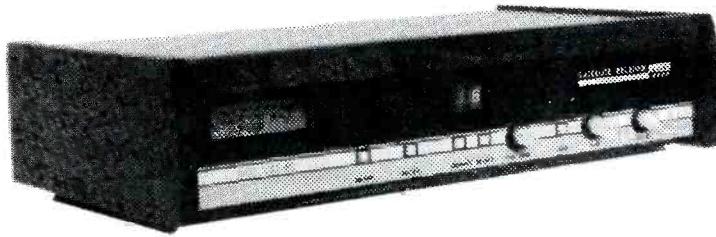

GILLASPIE 9600

- Infra-red wireless remote control
- Digital tuning
- Polarity reverse (Satcom/Westar)
- On/off switch on remote
- Built in A/B switch
- Large signal strength meter
- Automatic polarity control
- Attractive wood cabinet
- Built in channel ³/₄ modulator

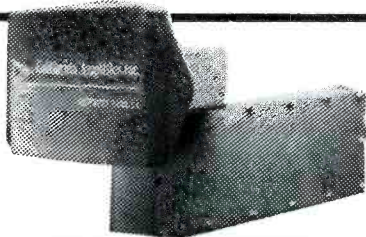

CAL AMP LNA'S
120° 100° 85°



SAT-PAK
LNA CABLES

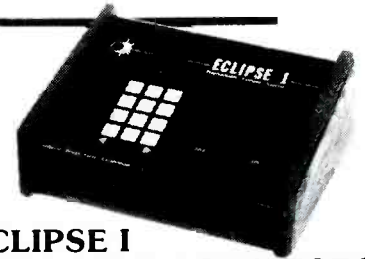

ECLIPSE I
PROGRAMABLE ACTUATORS

YOU CAN'T BEAT THE PRICE

ORDER NOW



(800) 221-6535
(212) 345-8000

ATTENTION DEALERS:

This is the system that you have been waiting for. An 8' Delta Gain antenna with low noise temperature at low angles, a wireless remote receiver that looks good and works great and has the features the others forgot. Quality LNA's, cables and accessories. This system is complete. You don't have to buy pipe, wire or connectors. It's light weight and can be installed by one man. **CALL FOR DEALER PRICES THAT CAN'T BE BEAT 800-221-6535.**

Circle (37) on Reply Card

TRITON MARKETING corp.
679 Remsen Avenue
Brooklyn, New York 11236

WHOLESALE
DISTRIBUTORS

(800) 221-6535
(212) 345-8000

Literature

A new short form catalog highlights major products included in Viz's full line of general-purpose test equipment. The catalog includes digital and analog multimeters, oscilloscopes, frequency counters, audio and RF generators, power-line monitors, isolation transformers and a full line of dc power supplies with analog and digital readouts.

Circle (106) on Reply Card

A new catalog describing **Chemtronics'** product line of electronic chemicals, soldering and desoldering braids is now available. The catalog describes a variety of electronic chemical products that offer solutions to all kinds of troubleshooting, engineering, quality control, testing and repair

problems found throughout the industry. Electronic chemicals described are electronic cleaners and degreasers, special purpose solvents, flux removers, lubricants, contact cleaners, conformal coatings, anti-static sprays, head/disc cleaners, tuner cleaners and freezing agents.

Circle (100) on Reply Card

Literature covering the complete offerings of **E.F. Johnson** new test prod and patch cord line now is available. The 4-page catalog describes the technical innovations of the new product line and includes complete product specifications and ordering information.

Circle (101) on Reply Card

A digital frequency counter wattmeter fact sheet from **Coaxial Dynamics** presents model FCW-10, a precision instrument that combines two critical operations into one compact, lightweight RF unit for laboratory or portable field service.



Compact lightweight LABORATORY/PORTABLE FREQUENCY COUNTER/WATTMETER Model FCW-10

Digital frequency counter and wattmeter: accurate precision accuracy, rugged portability and dual function in one compact R.F. instrument. Frequency, forward power and reflected power readings are easily completed by Model FCW-10, a single instrument with an video-characteristic 200-ohm module that can be inserted in the transmission line remote from the unit. The pick-up module determines the broad frequency and power ranges in a laboratory location and the unit power measurement are 100-117V, 50/60 Hz. Optional battery pack advantageously converts frequency counter wattmeter from a six to bench to a portable test service R.F. instrument. Battery pack automatically recharges when unit is plugged into an AC line. Stocked high impact lightweight plastic case, 3 1/2" x 8 1/2" x 9" - 3 pounds. 8 pounds with battery pack. American made.

COAXIAL DYNAMICS, INC.
1370 Greenwood Avenue
Channahon, Illinois 61418
708-426-4800



The sheet contains detailed specifications and illustrates its dual function. Featured highlights of the instrument include a fully integrated multifunctional digital frequency counter with range dc to 512MHz (1.3 GHz optional), wattmeter with LED position indicator and finger-touch rocker switches for both forward and reflected power.

Circle (102) on Reply Card

A revised catalog with the newest capacitors is available from **TRW Capacitors**. The catalog contains the information needed to select the appropriate type of capacitor for typical applications. Included in the catalog are sections on the following types of wound capacitors: metallized polycarbonate dielectric, metallized polypropylene, metallized polyester, polyester dielectric, polystyrene dielectric, and polyester di-



Capacitor Catalog

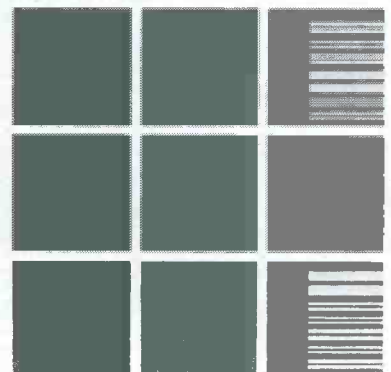

Maybe We're To Discrete About Our Discrete Products

Diode Specials

In Lots of 100

1N4148	\$3.60/100	1N4004	\$3.60/100
1N4001	3.00/100	1N4005	4.00/100
1N4002	3.25/100	1N4006	4.50/100
1N4003	3.40/100	1N4007	5.50/100

Transistor Specials

PN2222A	\$8.00/100	2N3906	\$12.00/100
PN2907A	8.00/100	2N3055	.65 ea.
2N3904	12.00/100		

Carbon Film Resistors

1/2 Watt 5% Tolerance

Now Only \$1.50/100

All 5% Values Available

Specializing in:

Resistors

Transistors

Diodes

SCRs

Full Wave Bridges

STOCKED
IN
DEPTH

And the Old and Exotic!

Call Liz and ask about her parts today!

We also purchase excess inventories. Call Martha about your parts today!

"Have You Kissed Your Computer Lately?"

Components Express, Inc.

1380 E. Edinger • Santa Ana, Calif. 92705 • 714/558-3972

TWX 910-595-1565 • ADVACON SNA • International Orders Welcome

Terms of Sale: Cash, Checks, Credit Cards, M.O., C.O.D. FOB Santa Ana.

Calif. residents add 6% sales tax.



Circle (38) on Reply Card

electric RC network. General uses of each type are indicated.

The 64-page catalog includes performance and electrical specifications such as curves of capacitance change, dissipation factor, insulation resistance vs. temperature for each capacitor type, and typical applications. Photos and dimensions of each unit are shown.

Circle (110) on Reply Card

A new 28-page catalog and specification manual from **REFAC Electronics** is a guide to the use of Opcoa LED lamps and displays. The Opcoa line described in this literature includes a broad range of lamps, special shapes, resistor and right-angle lamps, single and multidigits, and accessories, all with a variety of clear, diffused and color-diffused lenses, viewing angles, intensities, packages and colors.

Circle (104) on Reply Card

New brochures describing **RCA's** full line of video accessories includes catalogs covering general-purpose video accessories (Form No. 1J7106) for any make equipment, exact replacement accessories (Form No. 1J7108) for RCA equipment, and instrument accessories (Form No. 1J7116) for many popular brands.

Each piece includes photos to help identify the range of items available, along with a capsule description. The two video accessories folders also feature cross-reference charts that pinpoint usage for many products offered.

Circle (105) on Reply Card

How To Keep Yourself In Power, a new packet of articles about guarding computers and other vital electronic equipment against common irregularities in electrical utility power, is being offered by **Sola Electric**.

This selection of recently published articles is intended to provide a helpful overview of power protection. Included is a general article describing typical power problems and the various types of equipment available to solve them, plus supporting articles that more closely examine

two specific areas of concern—Uninterruptible Power Systems (UPS) and the special power-protection needs of microprocessor-based equipment.

Circle (108) on Reply Card

Dymarc Industries has announced the availability of a new brochure for their Clipstrip transient voltage suppressive strip. The brochure presents a detailed explanation of Dymarc's power protection circuitry. Common dangers from voltage hazards to all computer-based equipment are discussed, including such problems as spikes, surges, RF interference and transient overvoltages.

Circle (109) on Reply Card

A new 36-page catalog is now available detailing the complete range of precision, miniature hand tools from both the **Moody** and **Acu-Min** lines manufactured by **Moody Tools**.

The literature displays more than 200 precision miniature tools and tool sets, including slotted screwdrivers, cross recess drivers, hex keys, spline drivers, socket and open-end wrenches, machinists' scribers and pin vises, taps, dies and drills.

Circle (103) on Reply Card

A new 6-page brochure describing floppy disk drive testing equipment is available from **Teaco**. A full line of seven testers and 28 accessories covering applications from incoming inspection and depot service to field service are covered. The units provide direct hardware control and are not software dependent.

Testers described range from bench units that power the drive to the first hand-held, pocket-sized unit for field service.

Circle (107) on Reply Card

Global Specialties Corporation's 1983 edition of "Instruments for Testing and Design" features complete descriptions and specifications for Global's electronic test and design equipment, and has been expanded to include several new products and product categories.

Circle (113) on Reply Card

ATTENTION TECHNICIANS

- ★ JOB OPENINGS
- ★ MONTHLY TECHNICAL TRAINING PROGRAM
- ★ BUSINESS MANAGEMENT TRAINING
- ★ LOW COST INSURANCE
- ★ CERTIFICATION
- ★ TECHNICAL SEMINARS

All of this in a nonprofit international association for technicians

FIND OUT MORE:



R.R. 3 Box 564
Greencastle, IN 46135



SINCE 1950

- LEADING SPOKESMAN
- TRADE INFORMATION DISPENSER
- WATCHDOG
- NATESA SCOPE
- STANDARDS YARDSTICK
- CONSUMER RELATIONS
- PROBLEM SOLVER
- CONCISE PRACTICAL BUSINESS OPERATIONS MANUAL
- SERVICE CONTRACT MANUAL
- CUSTOMER PLEASING PROFIT PRODUCING ORDER FORMS
- PARTS PROCUREMENT EXPEDITOR
- SERVICE BUSINESS
- DIVERSIFICATION PLANS
- TECHNICIAN DEVELOPER

5930 So. Pulaski Rd. • Chicago, Illinois 60629

Opportunity knocks.

The professional world of the Electronics Service Dealer is rough. That's why we're working so hard to make it easier for you to operate a cost effective business. NESDA offers substantial savings on bank-card and insurance rates, business contacts, technical and management certification, and that's just the beginning.

Our members are kept informed about industry developments, and are offered the most comprehensive managerial and technical training programs available. Opportunity knocks. Don't let it pass you by.

For more information about the National Electronics Service Dealers Association, write to: NESDA, 2708 W. Berry St., Ft. Worth, TX 76109.

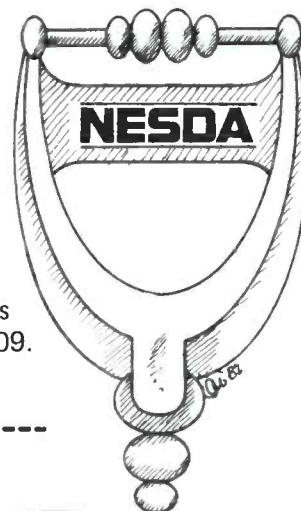

NAME _____

FIRM NAME _____

FIRM ADDRESS _____ Member of State Local Assn.

CITY _____ STATE _____ ZIP _____ PHONE _____

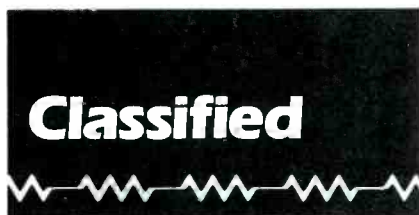

Advertising rates in the Classified Section are 50 cents per word, each insertion, and must be accompanied by payment to insure publication.

Each initial or abbreviation counts a full word.

Minimum classified charge \$10.00.

For ads on which replies are sent to us for forwarding (blind ads), there is an additional charge of \$3.00 per insertion to cover department number, processing of replies, and mailing costs.

Classified columns are not open to advertising of any products regularly produced by manufacturers unless used and no longer owned by the manufacturer or distributor.

FOR SALE

SCRAMBLED TELEVISION, encoding/decoding. New book. Theory/circuits, \$9.95 plus \$1 shipping. Workshop, Box 393ES, Dept. E, Bethpage, NY 11714. 7-80-tfn

TUBES FOR TV AND RADIO - 35¢ ea. Washington TV Service, 1330 E. Florence Ave., Los Angeles, CA 90001. 1-83-12t

CABLE TV CONVERTER/DECODER. LOWEST PRICE ANYWHERE. Oak N-12 or Jerrold SB-3 replacement \$79.00. Combo with 35 channel converter \$139.00. Jerrold DRX-3DIC with remote \$179.00. Send \$2.00 with order or for catalog, refundable with your order to: CK Electronics, 397 Route 18 East, Suite 377, East Brunswick, NJ 08816, 201-739-2671. 10-83-2t

COMPLETE JERROLD WIRELESS REMOTE/DE-SCRAMBLER - full warranty, \$159.00. Complete Oak descramblers, full warranty, \$169. Trap/filters in line type, \$49, 2 min. installation, SG613 transistors, only \$6.99. Original Toshiba 2SC1172B, only \$1.99 with hardware. 100/450, 80/480, 200/300, 40/450, 25 1st only \$1 each mixed or single lot. Super special while they last 800-860 41 each safety caps Zenith type, 10 lot only \$2.50. Bulk 2SC1172B only 50 lot, \$1.69. Redcoat Electronics, 104-20-68th Drive, Forest Hills, NY 11374, (212) 459-5088. 5-83-tfn

CABLE CONVERTERS, DECODERS. Free catalog! APS, POB 263, Newport, RI 02840. 6-83-12t

SUBSCRIPTION TV MANUAL, covers all three major scrambling systems, only \$12.95. Includes theory, circuits, waveforms and trouble shooting hints. Save your VIDEO GAME CARTRIDGES on EPROM with our EPROM duplicator. Plans \$9.95. Catalogue \$2.00, refundable. RANDOM ACCESS, Box 41770A, Phoenix, AZ 85080. 8-83-tfn

2SC1172B's, 50 LOTS - \$1.69; 2SC1308K's, original Sanyos, 50 lots - \$1.99; Cheater cords, 25 lots - 35¢; pol- and non-polarized, 1,000 ft. reels of RG 59 U. Coax Cable - \$39/roll. Minimum order \$75. Redcoat Electronics, 104-20 68th Drive, Forest Hills, NY 11375, 212-459-5088. 10-82-tfn

ELECTRONIC SURPLUS: CLOSEOUTS, LIQUIDATIONS! Parts, equipment stereo, industrial educational. Amazing values! Fascinating items unavailable in stores or catalogs anywhere. Unusual FREE catalog ETCO-011, Box 762, Plattsburgh, NY 12901. 6-78-tfn

SPRING SPECIALS on Popular Electrolytics - 40/450V - 75¢; 80/450V - 85¢; 100/450V - 95¢ 200/300V - \$1.05. Quantity 20 lot only. Minimum order of \$50. SUPER SPECIALS. Bulk Zenith safety capacitors 800-860, 12 lot only \$2.50 each. REDCOAT ELECTRONICS, 104-20 68th Drive, Forest Hills, NY 11375, 212-459-5088. 10-82-tfn

REPLACEMENT COLOR YOKES-DEALERS ONLY. Zenith 95-2501-2532-2887 etc. \$22.95. Magnavox 361380-1 etc. \$24.95. Sylvania \$24.95. American-made fuses in bulk-example 3AG 2 regular price .23 each our price .12 each. Factory packaged GE transistors at discounts. Example GE-20 regular price \$1.10 our price .65. Request circular on your letterhead. David Sims Enterprises, Inc., 665 East Jericho Tpke., Huntington Sta., NY 11746, 800-645-5030, NY State (516) 549-3925-1592. 10-82-tfn

TUBES - Receiving, Industrial and Semi-conductors, factory boxed. Free price list. Low; low prices. **TRANSLERONIC INC.**, 1365-39th Street, Brooklyn, NY 11218E, 800-221-5802, 212-633-2800. 5-82-tfn

TV TROUBLE ANALYSIS TIPS. Over 300 symptoms/remedies by circuit area; tough ones over the years. Save time and money. Send \$12.50 to CHAN TV, 8151 Grandview Rd., Chanhassen, MN 55317, 5-82-tfn

PRINTED CIRCUIT boards from your sketch or artwork. Affordable prices. Also fun kit projects. Free details. **DANOCINTHS INC.** Dept. ES, Box 261, Westland, MI 48185. 5-81-tfn

SONY-PANASONIC-RCA-ZENITH-EXACT REPLACEMENT PARTS-LARGE INVENTORIES-SEND PART OR MODEL NUMBERS-WILL UPS OR COD-GREEN TELE-RADIO DISTRIBUTORS, 172 SUNRISE HIGHWAY, ROCKVILLE CENTRE, NY 11570. 5-82-tfn

AUTOMOBILE RADIO and tape replacement parts: Delco, Chrysler, Philco-Ford, Motorola, Panasonic and many others. Large inventory. Laran Electronics, Inc., 3768 Boston Road, Bronx, NY 10469. (212) 881-9600, out of New York State (800) 223-8314. 5-79-tf

COLOR PICTURE TUBES direct from manufacturer. Prices from \$55 to \$75 exchange. One year warranty. Send your old tube ups to ATOLL Color Tubes, 6425 West Irving Park, Chicago, Illinois 60634. Phone: 312-545-6667. We also sell equipment for rebuilding CRT's. 9-83-3t

FOR SALE (CONT.)

ATTENTION TECH/SHOP OWNERS—Profits getting smaller with increasing cost of parts? Take advantage of our buying power and huge inventory on well known electronic products and replacement parts. Prices below dealer cost. Write for information. United Services Assoc., Old Grand Union Shopping Ctr., Rt. 9W, Stony Point, N.Y. 10980, 914-942-2173. 7-83-tfn

CB RADIO BOOKS, kits, modifications. Catalog \$1.00 refundable. APS, POB 263, Newport, RI 02840. 6-83-12t

SOUTHERN CALIFORNIA SALES AND SERVICE OPERATION available; Over 2 million gross 1982; Thirteen years in area with excellent growth and high visibility. Audio/Video Sales and Service Center, 26837 Bouquet Canyon Road, Saugus, California 91350, 805-255-5562. 9-83-3t

TELEVISION SALES & SERVICE, Established 1941, owner retiring, \$20,000 and will lease building. Phone 919-835-2302. Elkin, North Carolina, Nites only. 9-83-2t

PICTURE TUBE REBUILDING EQUIPMENT: Small or Medium Plant Operation. Production Capability—12 to 28 High Quality Tubes Daily. Call or write: TELECO, 2610 E. Busch Blvd., Tampa, FL 33612, 813-935-4002. 9-83-2t

ADVENT VIDEO PARTS and service available from professional electronics. Call 504-467-1717 for further information. 9-83-3t

SENCORE VA48 with all leads & manuals. Approx. 4 years of very light use. Excellent condition \$875. Jeff-1-215-868-8992 after 5pm. Bethlehem, PA 10-83-1t

MAKE TELEPHONE answering machine servicing simple & professional. Without tying up your phone lines, our ring simulator will activate any machine on the market. You can hear the outgoing message, give your message, and also have the availability to check machines that have remote capability. Send your check for \$85.00 made payable to PSI, INC., to cover cost of machine shipping and handling, or call: (201) 845-6669. PSI, Inc., is located at: 34, Route 17 North, Paramus, New Jersey, 07652. 10-83-1t

HELP WANTED

TUNER TECHNICIAN must have minimum of 5 years experience on tuner bench. Must know varactor and conventional tuners. Located in Dallas Texas area. Pay is \$5.00 per tuner. (817) 834-8201. 9-83-2t

BUSINESS OPPORTUNITIES

NORWALK, CALIFORNIA ESTABLISHED TV AND STEREO SERVICE AND SALES very busy money maker, excellent location, low rent, very good lease, 2300 square feet, 10 minutes to beaches and Los Angeles. \$40,000 includes inventory, large enough for living quarters, owner retiring, phone 213-863-1919. 11-82-tfn

TV TUNER REBUILDING BUSINESS. LOS ANGELES, CALIFORNIA 23 years same location, other interests, requires sale very reasonable, (213) 342-4745. 7-83-tfn

SPEAKER RECONING: Most makes, sizes, models. For prompt service send to Mercury Speaker Reconing, 2018 W. Division St., Chicago, Illinois, 60622; (312) 278-2211. 9-83-tfn

COLORADO'S WESTERN SLOPE BECKONS: Established R.V. Repair and Sales business. Good lease, good terms. Century 21-Old Homestead, John McDermott, 737 Horizon Drive, Grand Junction, Colo. 81501 or call (303) 243-5100. 10-83-2t

ESTABLISHED TV VIDEO SERVICE SHOP. Authorized for major brands. Complete inventory, late model equipment and van. Located in large Sun Belt city. \$37,500.00. Phone 915-592-3001. 10-83-1t

"TELEVISION PLUS authorized service center 8-Manufactures, EVE 516 599-4374." 9-83-2t

HIGH PROFITS—LOW INVESTMENT: with our CRT rebuilding equipment. Complete training and technical assistance. Guaranteed result. Atoll Television, 6425 W. Irving Park, Chicago, Illinois 60634; PH 312-545-6667. 8-83-3t

Bus. Opportunity (Cont.)

RAMPART SECURITY SYSTEMS DEALERS' sales are booming. The Rampart Franchise Program offers ENORMOUS PROFIT POTENTIAL PLUS EXCITING RESIDUAL INCOME. Our success and reputation are a result of a total business format approach for the EX-PLoding alarm market. Product, marketing and management training with complete backup has made success a reality for over 70 dealers. No experience necessary just a strong desire to succeed. Investment only \$15,000 backed by inventory. Call Bob Pollack (800) 523-8002 or write RAMPART INDUSTRIES, INC., 1 Oxford Valley, Suite 317, Langhorne, PA 19047. 8-83-tfn

LEARN TO REPAIR HOME VIDEO GAMES IN YOUR OWN SHOP! Did you know that more than 9 million HOME VIDEO games have been sold? Now you can learn to repair! Atari, Coleco, Intellivision, or Atari 400/800 computers in your own shop. Our courses are taught on VIDEO TAPE (Beta or VHS) and come with a manual containing all the necessary technical information you will need to do repairs. For more information or to order, call: Electronic Institute (800) 221-0834 (outside N.Y.) or (212) 377-0369 (in N.Y.) Customized live in shop training courses are also available, call for more information and price schedules. 7-83-tfn

ELECTRONIC TECHNICIAN JOBS DON'T PAY ENOUGH TO MAKE ENDS MEET. You spend several years training only to discover those "high paying electronic jobs" don't really exist. Believe me, I know, I've been there. You probably have too. To earn extra money, I did repair work on the side. This helped some, but it was time consuming, hard work and still didn't pay all the bills. I decided there must be a better way...and I found it! I thought about all the things electronics do, and from this, developed a new idea that is perfect for repair shops or the independent technician who needs extra income. It's easy to start, requires little investment, can be full or part time, has good profit potential but most importantly, it works. In fact, it turned out to be such a good idea, that I developed it into a guide book format complete with all technical advice and details. It is available for \$10.00. Ten dollars is not much to pay for extra income. Consider, this is less cost than a year's subscription to this magazine. And, is tax deductible. Also, if not convinced after reading, you may return it forthwith to me for a refund. New ideas are the only ones that make money and only for those who get them first. This is your chance to be the early bird. Send \$10.00 today to: Paul Yost CET, Box 29283, Indianapolis, IN 46229. 10-83-1t

WANTED

WANTED FOR CASH: 50, 53, 6AF6, 6HU8, 304TL, 4CX1000A, 4-1000A, all transmitting, special purpose tubes of Eimac/Varian. DCO, Inc., 10 Schuyler Avenue, North Arlington, New Jersey 07032. Toll Free (800) 526-1270. 5-82-tfn

To get more information...

on items advertised or described in this publication, use the Reader Service Card.

As a free service for our readers, we forward your inquiry to the product's manufacturer. Reader Service Card is pre-addressed.

Advertisers' Index

Reader Service Number		Page Number
34	Active Electronics	58
32	All Electronics Corp.	57
8	BBC Metrawatt Goertz	15
17, 27	B&K Precision	39, 49
21	Chemtronics, Inc.	43
38	Components Express, Inc.	60
39	Consolidated Electronics Inc.	64
33	Consumer Products Distributing Co. Inc.	57
31	Creative Electronics	56
35	Dage Scientific Instruments	58
29	Dandy Mfg., Co.	51
16	Digitron Electronic	38
	ETA	61
28	Electronic Specialists, Inc.	51
	General Electric Co. TV Business Div.	41
30	High Tech Marketing Co.	56
23	Krista Radio	47
4	MCM Electronics	1
	NATESA	61
	NESDA	62
	NRI Schools/Electronics Div.	17
10, 13	North American Philips	21, 27
26	Oelrich Publications	57
9	Omnitron Electronics	19
15	Optima Electronics	38
1	PTS Corp.	IFC
	Philips ECG	7
18	Primefax	40
24	Projector-Recorder Belt Corp.	47
	RCA Distributor and Special Products Div.	28
11	Howard W. Sams & Co.	23
36	Satellite TV Week	58
2, 3	Sencore	BC
12	Sony	25
	TCG/New-Tone Electronics, Inc.	42
6	Tektronix, Inc.	9
37	Triton Marketing Corp.	59
19	Wahl Clipper Corp.	40
5, 7	Winegard Co.	5, 13
	Zenith Radio Corp.	IBC

MAY THE 'SOURCE' BE WITH YOU!

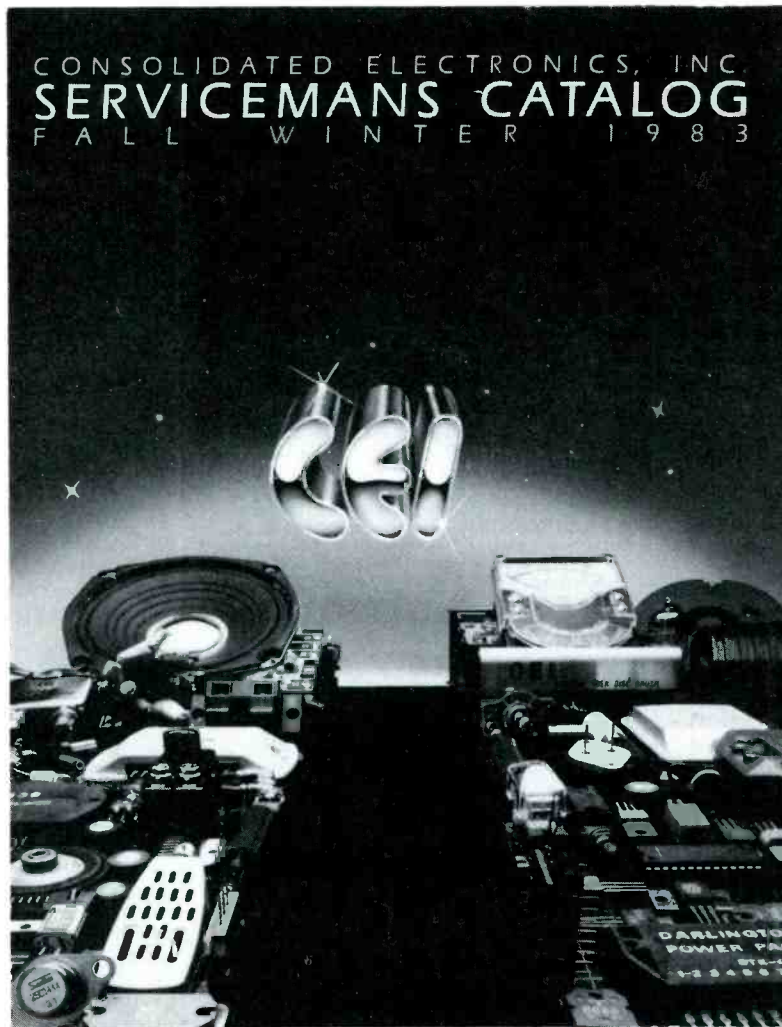

The **Source** can be with you, if you call us TOLL FREE. The 'Source', CEI's new catalog, is offering you top quality parts at low prices. We've slashed **80%** of our prices in this catalog. We at Consolidated Electronics are even offering a **two year warranty** on every part. Not only that, we're offering **FREE SHIPPING AND HANDLING**. Just call us toll free for details.

When you order from us you'll never want anyone else except us. We'll have your order packaged and shipped out the very next day! We've been commended and are proud of our fast service. With Consolidated Electronics there are no long delays, waiting and waiting for your orders to arrive. When you order from us you'll find that **CEI IS YOUR COMPLETE ELECTRONICS PARTS SOURCE!**

CALL TOLL FREE TODAY!

1-800-543-3568
NATIONAL WATS

IN DAYTON, OHIO, CALL (513) 252-5662

1-800-762-3412
OHIO WATS



Consolidated Electronics, Incorporated

Circle (39) on Reply Card

It's prime time now for cashing in
on the big, wide, wonderful world of
ZENITH VIDEO/AUDIO ACCESSORIES

**There's more in it for
you now than ever before!**

It's mind boggling! The number of your customers who are tapping into their TVs for so many uses besides tuning in news, sports and the usual TV fare! At last TV's beginning to fulfill its function as a combination home entertainment and information center!

That's why now is the time, the prime time, for capitalizing on this market of born-again videophiles with Zenith's biggest, broadest-ever line of video, audio and telephone accessories!

Look again and see how Zenith anticipated the videophiles' needs with the Video Organizer and a whole host of TV accessories packaged and labeled to sell on sight from their own Zenith floor display.

Also incorporated into this, the biggest and broadest-ever Zenith line of video/audio/telephone accessories are indoor and outdoor antennas... new super-lightweight stereophones... and the Zenith Spike Suppressor to protect the TVs and appliances you sell or service from damaging high voltage surges the year-around.

What an opportunity! A line of video/audio/telephone accessories backed by a name so powerful it alone does everything but write the order for you!

Now's the time, the prime time, to call the Parts Manager at your Zenith distributor's. Call now so he can help you write your opening order in the video/audio/telephone accessory business! And tell him Zenith sent you!



The quality goes in before the name goes on.®

Zenith Radio Corporation
Service, Parts & Accessories Division
11000 Seymour Avenue
Franklin Park, Illinois 60131

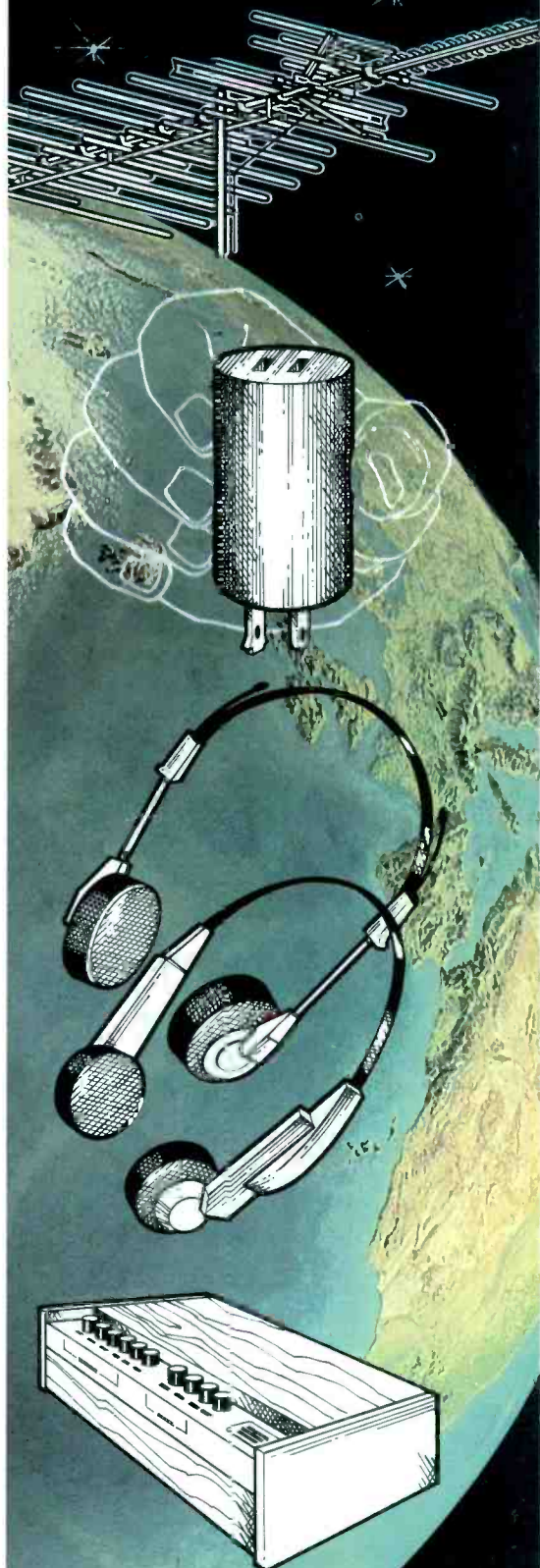

Double Your Troubleshooting and Testing Productivity . . . Or Your Money Back!

Six-digit readout: Automatically tracks every CRT test. We call it digital autotracking. It's patent pending.

Bright dual-trace CRT: 60 MHz (-3 dB); 100 MHz (-12 dB).

Delta PPV, Time, Freq: Measure any part of a waveform for PPV, time or frequency using Delta measurements. Just dial in the waveform section you want to measure and push.

Simplify Freq ratio tests: Automatically compare input/output ratio of multiply/divide stages from 1:1 to 1:999,999 with the push of a button.



Autotracking DCV, PPV, Freq: Measure DCV to .5%; PPV to 2%; freq. to .001%. Just push a button for either Channel A or B.

One probe input: One probe input per channel for all measurements - digital and scope - with 5 mV to 2000 V² measuring range. (2 lo-cap probes provided.)

Super sync: ECL provides rock-solid sync trigger circuits with only 4 controls; includes TV sync separators for video work.

U.S. Patent Pending
Financing Available

The first scope with push button digital readout. If you use general purpose oscilloscopes for troubleshooting or testing, we can double your present productivity with the SC61 Waveform Analyzer, the first instrument to turn every conventional scope measurement into an automatic digital readout.

No more graticule counting. Connect only one probe to view any waveform to 100 MHz. Then, just push a button to read DCV, PPV, frequency and time — automatically!

There are no graticules to count or calculations to make, which speeds every measurement.

The digital readout is from 10 to 10,000 times more accurate as well.

Plus you have everything you want to know about a test point, at the push of a button, which speeds troubleshooting tremendously.

A special Delta function even lets you intensify parts of a waveform and digitally measure the PPV, time or frequency for just that waveform section.

And it's neat. No more tangled leads, piles of probes or dangling cords. The SC61 is an entire test station in one unit.

The one and only. There are other scopes with digital readout, but none of them completely automate every conventional scope measurement so you can automatically analyze any waveform without counting one single graticule. Totally automatic waveform analyzing at the push of a button. It will make all the difference in your productivity.

Double your productivity. When we say the SC61 will double your productivity, we're being conservative. We've seen cases of

three, four, even ten time increases in productivity with this first-of-its-kind, automated oscilloscope. Every situation is different, however, so try the SC61 and judge for yourself. Here's our offer.

Money back guarantee. If the SC61 does not at least double your productivity during the first thirty days, you may return it for a full refund, including freight both ways.

Call today. Get the entire SC61 Waveform Analyzer story. Call toll-free today, and ask for our eight page color brochure. It could be the most productive call you make this year!

**Phone Toll-Free
1-800-843-3338**

Alaska, Hawaii, Canada and
South Dakota call collect
(605) 339-0100

SENCORE
3200 Sencore Drive, Sioux Falls, SD 57107